



**NIBIO**

NORWEGIAN INSTITUTE OF  
BIOECONOMY RESEARCH



**SNS**

Nordic Forest Research

NIBIO BOOK | 5 (6) 2019

# Forest Operations in Response to Environmental Challenges

Proceedings of the Nordic-Baltic Conference on Operational Research (NB-NORD),  
June 3-5 2019, Honne, Norway

Simon Berg & Bruce Talbot (eds.)

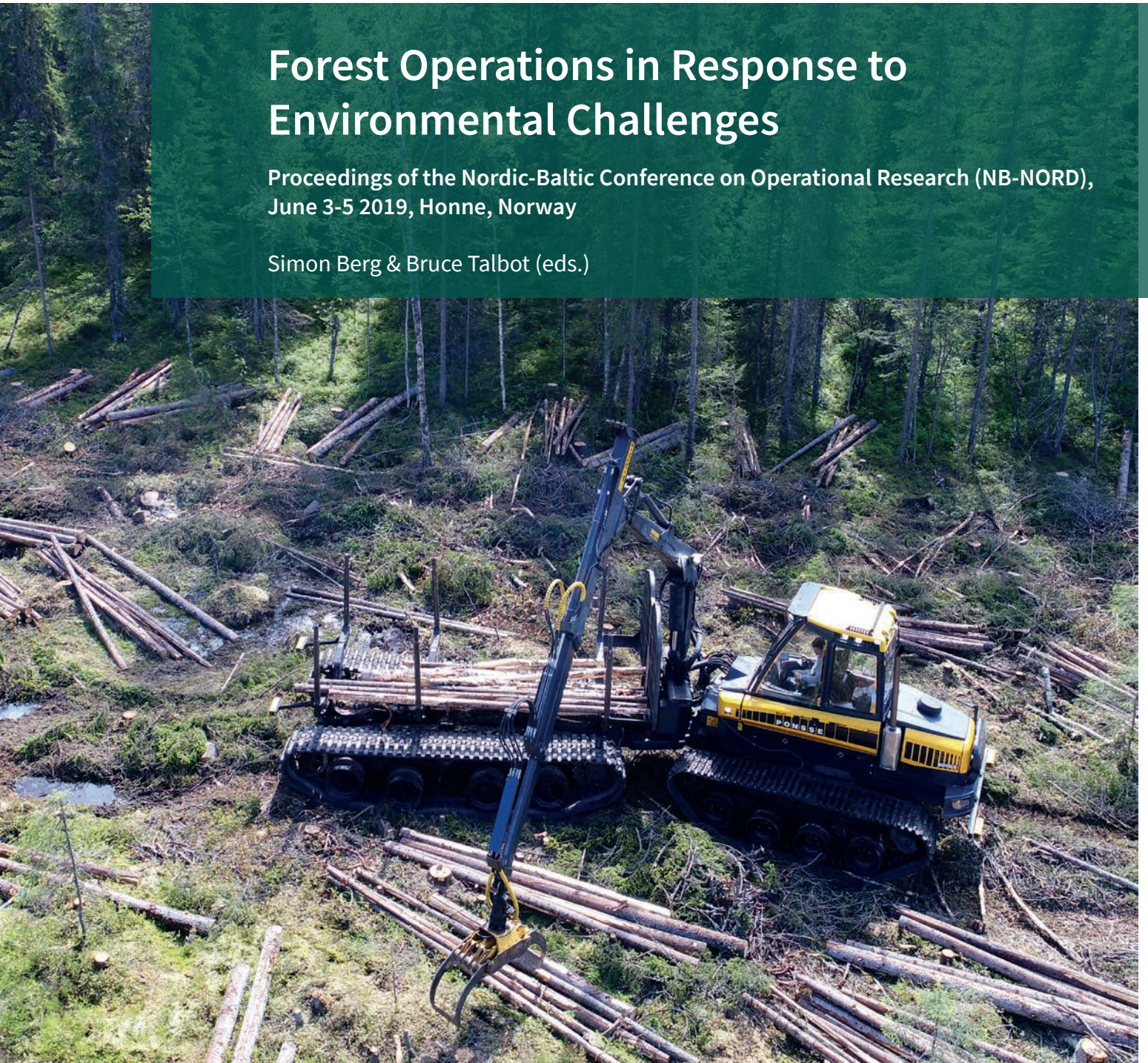

# Forest Operations in Response to Environmental Challenges

*Proceedings of the Nordic-Baltic Conference on Operational Research  
(NB-NORD)  
June 3-5 2019, Honne, Norway*



Supported by Nordic Forest Research, SNS

Redaktører: Simon Berg & Bruce Talbot

Tittel: Forest Operations in Response to Environmental Challenges

Under Tittel: Proceedings of the Nordic-Baltic Conference on Operational Research (NB-NORD) June 3-5 2019, Honne, Norway

Fagredaktør: Bjørn Håvard Evjen

Forsidefoto: NIBIO

Forsidefoto: The OnTrack forwarder at work near Lillehammer

NIBIO BOK 5(6)2019

ISBN: 978-82-17-02339-5

ISSN: 2464-1189

## ***Forest Operations in Response to Environmental Challenges***

Firstly, a very warm welcome to Norway and this conference of the joint Nordic-Baltic Network for Operational Research (NB- NORD) being held for the second time on the premises of the Norwegian Forestry Extension Institute (Skogkurs) in Honne. The NB-NORD network has gone by a number of names in the past but still serves the same purpose, i.e. to strengthen collaboration and promote synergies between researchers, research topics and research methods in forest operations in the Nordic-Baltic region.

The Nordic-Baltic region accounts for roughly half of the total timber volume harvested in the EU-28, and the methods used in the harvesting of this timber are largely based on the work of participants reflected in this conference and their predecessors. At the same time, researchers in this region are clearly asserting themselves in the EU H2020 framework, playing central roles in a number of flagship projects, while strategically building competencies in relation to future challenges and opportunities. The NB-NORD network continues to provide an important platform also for this wider collaboration.

The theme selected for the current event '*Forest Operations in Response to Environmental Challenges*' is a timely effort to showcase solutions to the challenges brought about by the changing conditions in the forests we work with. Not only the Nordic-Baltic region, but forestry in Europe and much of the world faces increasing challenges related to forest fires, wind-throw, beetle infestation, low soil and road bearing capacity, erosion and landslides, as well as changes in bio-geochemical cycles. While this might seem a long list of issues to address in addition to providing the efficiency improvements needed in keeping the sector competitive, a look through the programme of this conference shows that NB region clearly meets the needed diversity in topics and unity in ambitions.

NB-NORD is funded under the umbrella of SamNordisk Skogsforskning (SNS) or in English, Nordic Forest Research. SNS is a cooperative body, financed with Nordic funds under the auspices of the Nordic Council of Ministers that strives to enhance benefits for the Nordic region and contribute to a sustainable society. When SNS endorse forest operations research by once again funding this network, it is with the same goals in mind, those of enhancing benefits for the Nordic region and contributing to a sustainable society. We acknowledge these expectations and are grateful for the framework provided through NB-NORD funding which allows us the opportunity to address and ultimately meet them.

So on behalf of Norwegian forestry and all parties involved in organising this meeting, I would like to wish all the participants a fruitful and enjoyable conference in Honne. On behalf of all the conference participants as well as the Nordic-Baltic researchers in forest operations that were unable to attend, I want to express our joint appreciation to SNS for sustaining this highly active and beneficial research network.

---

Bjørn Håvard Evjen

Director - Division for Forestry and Forest Resources  
Norwegian Institute for Bioeconomy Research, NIBIO  
Ås, Norway.



**NIBIO**

NORWEGIAN INSTITUTE OF  
BIOECONOMY RESEARCH



# Table of contents

<b>1</b>	<b>Weather and Climate Impacts</b>	
1.1	The weather conditions as an impact factor on production and cost of wood fuels.....	11
	Marek Irdla*, Allar Padari, Peeter Muiste	
1.2	A common framework for analyzing effects of weather variations on wood procurement – reporting from era-net project multistrat .....	12
	Karin Westlund+, Petrus Jönsson, Dag Fjeld*, Peter Rauch, Christoph Kogler	
1.3	Working with the weather - tools and tricks for more resilient wood supply .....	13
	Dag Fjeld*	
1.4	Compact-class forest machines as a tool for reduction of greenhouse gas emissions .....	14
	Santa Kaleja*, Andis Lazdins, Agris Zimelis	
1.5	The usefulness of boreal forestry as a tool for mitigating climate change .....	15
	Rolf Björheden*	
<b>2</b>	<b>Roads and Transportation</b>	
2.1	Ash roads: Cost -Methods -Performance .....	19
	Mikael Bergqvist+, Daniel Noreland*, Hagos Lundström	
2.2	Strain measurement of gravel road with loaded HCT-vehicle combination .....	20
	Mauri Haataja*, Veikko Pekkala	
2.3	Development of collection and utilisation of private road data .....	21
	Pirjo Venäläinen*	
2.4	Calculation model for transport capacity for timber trucks - development of the decision support system NETRA.....	23
	Permångs M., Edlund B., Bergström D.*	
2.5	A method of finding HCT corridors.....	24
	Höök C.*, Asmoarp V., Edlund B., Bergström D.	
2.6	New Finnish truck regulations may change the supply chain of forest fuels .....	27
	Harri Ruokojärvi, Pirjo Venäläinen, Askko Poikela, Veli-Pekka Kivinen, Bo Dahlin*	
<b>3</b>	<b>Mitigating Site Impact</b>	
3.1	The effects of an extra axle on forwarder wheel rut development .....	31
	Øivind Østby-Berntsen, Dag Fjeld*	
3.2	The OnTrack forwarder – results and experiences from constructing and testing a rubber-tracked forwarder with low ground pressure .....	32
	Talbot, B.*, Björheden, R., Poikela, A., Lazdiņš, A., Kopetzky, M.	
3.3	Identification of wet areas using airborne LiDAR data .....	35
	Ivanovs Janis*, Lupikis Ainars, Karklina Ilze	
3.4	Registration of wheel rutting and ground condition class in Danish forestry using high resolution LiDAR data and digital legacy maps .....	36
	Ingeborg Callesen*, Bo Brockmann, Lene Fischer	
3.5	Real time measuring and mapping of soil disturbance .....	37
	Astrup, R , Nowell, T*, Talbot, B.	
3.6	Bearing capacity measurements during forest roads maintenance and construction, praxis in JSC Latvia’s State Forests .....	39
	Nora Sukite*	

## 4 Remote sensing and computer vision

4.1 Mapping forest attributes using accurately positioned tree-level harvester data and airborne laser scanning.....	43
Endre Hansen*, Marius Hauglin, Matti Maltamo, Terje Gobakken, Erik Næsset	
4.2 Possibilities of automatic quality measurement in wood harvesting .....	44
Heikki Ovaskainen*	
4.3 Detecting stem damage by applying machine vision .....	45
Kalle Kärhä*, Jyry Eronen, Teijo Palander, Heikki Ovaskainen <sup>4</sup>	
4.4 Using RGB images and machine learning to detect and classify Root and Butt-Rot (RBR) in stumps of Norway spruce .....	47
Ahmad Ostovar, Bruce Talbot, Stefano Puliti, Rasmus Astrup, Ola Ringdahl*	
4.5 ALS-based estimation of vegetation hindering cut-to-length harvesting operations .....	48
Blanca Sanz, Jukka Malinen*, Teppo Hujala, Timo Tokola	
4.6 Remote sensing-based forest road trafficability modelling.....	49
Tuomo Puumalainen*, Jussi Peuhkurinen, Vesa Leppänen	
4.7 Automatic generation of shallow ditch network in forest using LiDAR data and multispectral satellite imagery.....	51
Raitis Melniks*, Janis Ivanovs, Andis Lazdins	
4.8 What Global Forest Watch data can tell us about timber harvesting practices - a Norwegian case study .....	52
Fernando Rossi, Johannes Breidenbach, Stefano Puliti, Rasmus Astrup*, Bruce Talbot	

## 5 Productivity and Efficiency

5.1 Impact of sorting grip and tilting grip on productivity of forwarding of logs in commercial thinning .....	57
Lazdiņš Andis*, Zimelis Agris, Kalēja Santa, Saule Guntis	
5.2 Impact of feed rollers on productivity, log damages and fuel consumption during harvesting .....	58
Polmanis Kaspars*, Zimelis Agris, Spalva Gints	
5.3 Long-term follow-up study on fuel consumption of harvesters and forwarders in wood harvesting in Finland – Preliminary results.....	59
Hanna Haavikko*, Kalle Kärhä, Heikki Kääriäinen, Teijo Palander	
5.4 Modeling harvester's productivity applying statistical machine learning methods to standard machine monitoring data.....	60
Paula Jylhä*, Pekka Jounela, Eero Liski, Markku Koistinen, Heikki Korpunen	
5.5 Productivity, logging costs and wood value for harwarder in final felling .....	61
Rikard Jonsson*	
5.6 Automation of harwarder work – evaluation of effects on performance and user experience .....	62
Martin Englund*, Jussi Manner, Rikard Jonsson, Anders Mörk	
5.7 Silvismart, an EU-wide Efficiency Portal for forest operations.....	63
Simon Berg*, Bruce Talbot, Rasmus Astrup	
5.8 Uncovering the technical performance potential of CTL harvesters.....	65
Rolf Björheden*	

<b>6 Forest Regeneration and Small Tree handling</b>	
6.1 Site preparation: history, present situation and the future.....	69
Lars-Göran Sundblad*	
6.2 Improved forest regeneration operations in Latvia – transfer and adaption of Nordic technologies -mechanized planting.....	70
Dagnija Lazdina*, Karlis Dumins, Toms Arturs Stals, Kristaps Makovskis, Timo Saksa	
6.3 State-of-the-art of mechanized tree planting and pre-commercial thinning operations in Finland.....	72
Taru Timonen, Kalle Kärhä*, Markku Oikari, Markus Strandström, Heli Peltola, Kari Kuusniemi, Jukka Piipponen	
6.4 Simulating concepts for fully mechanized stand regeneration.....	73
Jussi Manner, Isabelle Bergkvist, Gert Andersson*, Petrus Jönsson, Lars-Göran Sundblad, Back Tomas Ersson	
6.5 Flowcut: A felling head for continuous felling and accumulation, the second evaluation.....	74
Örjan Grönlund, Henrik von Hofsten, Maria Iwarsson Wide*	
6.6 Why are undergrowth trees still pre-cleared before first thinning operations?.....	75
Bergström D. *, Ersson B.T.	
6.7 Visibility of tree damages from the strip road.....	76
Heikki Ovaskainen*, Niklas Peltoniemi, Teijo Palander, Kalle Kärhä, Jyry Eronen <sup>4</sup>	
<b>7 Forest Contracting and Supply Chain Management</b>	
7.1 A cost- and productivity calculator for forest harvesting operations in Norway .....	81
Endre Hansen*, Mikael Fønhus, Bruce Talbot	
7.2 Variations in machine utilization and overtime due to the choice of supply chain strategy .....	82
Lars Eliasson*, Anders Eriksson, Sara Holappa Jonsson	
7.3 Contractor forestry in Northern Sweden: an overview of firm characteristics and economic performance.....	83
Thomas Kronholm*	
7.4 Identification of success factors of a wood harvesting enterprise.....	85
Pasi Rikkonen, Katri Hamunen, Paula Jylhä*	
7.5 A new integrated model for production and flow management .....	87
Sara Holappa Jonsson*, Victor Asmoarp	
7.6 Improving resource efficiency in the forest sector through digital declarations of raw material properties.....	88
Maria Nordström *, Johan J Möller, Sara Holappa Jonsson, Lars Wilhelmsson, Thomas Grahn, Anders Lycken, Lars Wallbäcks, Dan Olofsson.	
<b>8 Posters</b>	
8.1 AVATAR – Advanced Virtual Aptitude and Training Application in Real Time .....	91
Jaeger, D*, Björheden, R., Talbot, B.	





# 1 Weather and Climate Impacts



## 1.1 The weather conditions as an impact factor on production and cost of wood fuels

*Marek Irdla<sup>1</sup>\*, Allar Padari<sup>1</sup>, Peeter Muiste<sup>1</sup>*

<sup>1</sup>Estonian University of Life Sciences, Kreutzwaldi 5, 51014 Tartu

*\*Corresponding author: marek.irdla@student.emu.ee*

**Keyword:** bioenergy, harvesting, supply, wood chips

### Background

Estonian national goal according to the Long-term Development Programme for the Estonian Energy Sector up to year 2030+ is to decrease the GHG emissions by year 2050 by 80% compared with the year 1990. Achieving the targets, the use of wood fuels should increase. But due to different environmental restrictions the harvesting volumes are forecasted to decrease. In the situation of limited resources the production of wood fuels should be carried out perennially and efficiency of production becomes especially essential. Among different factors influencing the supply chain is the air temperature. As the precise data about weather conditions and the costs of production of wood fuels of a specialized producer were available for a several year period, the goal of the case-study was defined - to analyse the impact of precipitation and air temperature to the price formation of whole chain of production of wood chips in Estonian conditions.

### Material and Methods

The initial data from TMK Energy Lõuna company covered 2 different types of chippers and 4 different types trucks. All machines were equipped with a GPS tracking device (Dynafleet by Volvo and Navirec) which records the route and the fuel consumption. During the study all costs and revenues related to the concerned machines were accounted. The source for initial data about the precipitation and air temperatures was the Estonian Weather Service.

### Results and discussion

As a result of analysis the impact of weather conditions on production costs of wood fuels was determined:

1. Average or strong links are between fuel consumption, mileage, engine working time, number of stops and average speed
2. Fuel consumption has a negative relationship with mileage, engine working time and average speed
3. Fuel consumption has a positive relationship with the number of stops
4. The negative relationship is in the number of stops with mileage, engine working time and average speed

## 1.2 A common framework for analyzing effects of weather variations on wood procurement – reporting from era-net project multistrat

*Karin Westlund<sup>1</sup>, Petrus Jönsson<sup>1</sup>, Dag Fjeld<sup>\*2</sup>, Peter Rauch<sup>3</sup>, Christoph Kogler<sup>3</sup>*

<sup>1</sup>Skogforsk, the Forestry Research Institute of Sweden, <sup>2</sup>NIBIO, Norwegian Institute of Bioeconomy Research, <sup>3</sup>BOKU, Universität für Bodenkultur, Wien

*\* Presenter*

*+Corresponding author: [karin.westlund@skogforsk.se](mailto:karin.westlund@skogforsk.se)*

**Keyword:** wood procurement, seasonal effects

### Abstract

Extreme weather conditions, making procurement volatile, are to come with changing climate scenarios and will affect the procurement instantly. The aim of the project was to find a first synoptic and common framework to describe the impact of weather variations on wood procurement.

Three countries have collected data from wood production and transport as well as weather data from the years 2015 and 2016. The data have been statistical analyzed to find correlations between wood procurement and weather effects. A common simplified framework was introduced to find the most systematic weather factors influencing wood procurement.

For the Swedish case, the effect from the combination of snow depth and temperature were the only effects which could be seen had an impact on production. Though a low degree of significance, classes of snow depth indicated that a snow cover less than 0,5 meters together with high temperatures, above zero, gave an impact on production. The effect of the combination precipitation and high temperatures were found to influence the production most. The weather effects were also tested on transport. Surprisingly no such effects can be found. Transport was found to strictly follow the production inventory.

The impact of precipitation during temperatures around and above zero degrees have the largest impact on production resulting in deviations from procurement patterns, more than the effects of a deep snow cover. Still, the available data material used covered two years together with abbreviations and the framework needs to be further developed.

## 1.3 Working with the weather - tools and tricks for more resilient wood supply

Dag Fjeld\*

<sup>1</sup>NIBIO, Norway

\*Corresponding author: [dag.fjeld@nibio.no](mailto:dag.fjeld@nibio.no)

**Keyword:** wood supply, weather modelling, coastal climate, resilience

### Abstract

Seasonal variations in wood supply are linked to the regional operating environment. This study constitutes the Norwegian contribution to Era-Net MultiStrat (Multimodal strategies for more resilient wood supply) covering oceanic, sub-arctic and continental climate zones. The oceanic zone is characterized by considerable seasonal variation in both temperature and precipitation. The goal of the study was to seek solutions for more resilient wood supply under these conditions.

The study started with a general mapping of wood supply management processes including common demand and supply risks (WP1). The work continued with analysis of three years of production and transport reports (2014-2016) with tracking of roadside stocks and transport lead times (WP2). Daily temperature, precipitation, and snowpack were tracked with data from 65 surrounding weather stations.

A simple multimodal transport problem with a rolling selection of planning horizons was then used to find the efficient multimodal solutions for the core, adjacent and peripheral supply regions through 12 balance periods per year (WP3). The transport analysis covers 65 supply districts feeding 6 assortment groups to 10 mills via 11 shipping terminals. The transport analysis varied both vessel cargo capacity and cargo collection practices. The results demonstrated a wide range of solutions to ensure roundwood availability with limited increases in system costs.

While the transport analysis demonstrated the contribution of the multimodal solutions to structural flexibility, it also revealed a bottleneck for resilience of the wood supply system; seasonal variation in truck transport output (m<sup>3</sup>km/week). The geographical distribution of seasonality showed the main source to be one particular supply region. A subsequent wood supply planning workshop with production managers indicated that a bottleneck for improved production planning was short wood purchase and planning horizons. A simple optimization experiment was therefore set up to quantify the feasibility of more specific site-type selection according to actual soil and seasonal weather conditions for the selected region. On-line grid-based groundwater modeling was used to monitor weekly geographical variations in bearing capacity and the experiment provided a plausible re-scheduling of flows to reduce variation in delivery volumes and transport output.

## 1.4 Compact-class forest machines as a tool for reduction of greenhouse gas emissions

*Santa Kaleja*<sup>\*1</sup>, *Andis Lazdins*<sup>1</sup>, *Agris Zimelis*<sup>1</sup>

<sup>1</sup>Latvian State Forest Research Institute “Silava”

*\*Corresponding author: santa.kaleja@silava.lv*

### **Keyword:**

### **Abstract**

The climate change mitigation targets in energy and transport sector may become one of the key drivers for considerable changes in selection of harvesting technologies. The fuel consumed in harvester and forwarder engine and for relocation of the machine, as well as productivity are the main factors affecting GHG emissions in harvesting. The studies carried out in Latvia approves that compact class and medium-sized harvesters with engine capacity from 44 kW to 136 kW (fuel consumption 5-12 L h<sup>-1</sup>) demonstrates similar productivity in pre-commercial thinning, thus choosing of compact-class machine may result in significant reduction of GHG emissions. The aim of the study is to estimate GHG and cost reduction potential in forest thinning by utilization of compact-class forest machines in comparison to conventional harvesting technologies. According to the studies in Latvia Vimek 404 T5 performance rates are better than of the conventional middle-sized harvesters in pre-commercial and the 1st thinning, regenerative felling of grey alder (if  $D_{1.3} < 20$  cm) and vegetation cleaning operations (ditches, abandoned farmlands). Cost of Vimek 404 T5 harvester working hour is by 34 € smaller than of a middle-sized harvester. However, it should be noted that the costs are significantly influenced by the utilization rate and salary rates. If using compact-class harvester and forwarder in thinning, fuel consumption and GHG emissions decreases by 27% and 36% accordingly. Changing planning of utilization of forest machines and using integrated approach could lead a reduction of the GHG emissions in forest operations by 10%.

## 1.5 The usefulness of boreal forestry as a tool for mitigating climate change

Rolf Björheden\*<sup>1</sup>

<sup>1</sup>Skogforsk

\*Corresponding author: [rolf.bjorheden@skogforsk.se](mailto:rolf.bjorheden@skogforsk.se)

**Keyword:** Boreal forestry, Climate change, Carbon sink, Carbon dioxide emissions

### Abstract

It is commonly accepted that the global climate is changing as a result of increasing emissions of carbon dioxide. The content of CO<sub>2</sub> in the atmosphere has increased by 46 % from the 19th century to today. How forests are managed is discussed from a climate mitigation perspective. Forests absorb CO<sub>2</sub> and stores carbon as forest biomass.

Through a review, Swedish forests as a carbon sink, the impact of Swedish forestry on carbon flux and the substitution effects of Swedish forest products were analysed.

The inventory of Swedish forests is 3,2 billion m<sup>3</sup> of stemwood, with an additional 2,6 billion m<sup>3</sup> of branches, stumps etc. This corresponds to 1 270 Megatons of carbon (Mt C). The carbon stock of forest soils represents 1 360 Mt C (excluding histosols, containing 510 Mt C).

The carbon flux of managed forests includes biomass yield, harvesting and losses of tree biomass and CO<sub>2</sub>-emissions from forest operations including road management and transports. The yield is 121 M m<sup>3</sup> stemwood, from which harvesting and other losses subtract 96 M m<sup>3</sup>. Annually, 25 M m<sup>3</sup> is thus added to the inventory, representing 9 Mt C. Emissions of CO<sub>2</sub> from total forest operations represent 0.26 Mt C. In Sweden, the 'forestry carbon flux' is currently -8.74 Mt C•yr<sup>-1</sup>. The build-up of inventory over the last century increased the carbon pool by 590 Mt C.

Substitution effects occur when fossil carbon compounds are replaced by forest biomass. The effect amounts to -0.47 t CO<sub>2</sub> for each m<sup>3</sup> harvested. For the Swedish forestry sector, the effect equals 40 Mt CO<sub>2</sub> C•yr<sup>-1</sup>.

Swedish total CO<sub>2</sub>-emissions are 52,9 Mt CO<sub>2</sub> C•yr<sup>-1</sup>. The sequestration of forestry, through increased inventory (32 Mt CO<sub>2</sub>), added to the substitution effect of forest products (40 Mt CO<sub>2</sub>) overcompensates for these emissions.

Swedish forestry manages large stocks and flows of carbon, making it a key asset for minimizing climate impact. This usefulness depends on maintaining a high net production. In forests left for free development, no net sequestration occurs once the carbon sink has been filled.





## 2 Roads and Transportation



## 2.1 Ash roads: Cost -Methods -Performance

Mikael Bergqvist<sup>+1</sup>, Daniel Noreland<sup>\*1</sup>, Hagos Lundström<sup>†</sup>

<sup>1</sup>Skogforsk

\* *Presenter*

<sup>†</sup>*Corresponding author: mikael.bergqvist@skogforsk.se*

### **Keyword:**

### Background

Fly ash from combustion plants has previously been proposed as a reinforcement material in forest roads. Increased bearing capacity has been shown on test routes in a number of studies and leaching from the roads has been low. However, something that has not been studied is the economic aspects of ash reinforcement in the light of the technical result and the practical execution of the reinforcement measure.

### Material and Methods

The purpose of the project is to investigate the technical, environmental and economic conditions for using fly ash from the combustion of wood fuel as reinforcement material in forest roads. Together with SCA, Skogforsk has carried out a practical study with ash mixed in the roadbase of two test roads near Sundsvall. Strength properties, environmental impact and construction costs are studied. Four different methods for preparing the road material with ash are investigated:

- mix on the road with grader
- preparation in crushing plant
- preparation in mixing bucket
- mixing with a road reclaimer

The mechanical properties of the resulting pavement are examined with dynamic cone penetrometer and fall weight deflectometer. Leaching is examined by water samples in the road ditches. The economy is examined through time studies for the construction measures. The results are compared to a reference road section constructed by conventional methods.

### Results and discussion

In all studied cases, leaching is low. The cost of ash roads is higher than conventionally built roads but depends strongly on actual conditions. If a crusher is available for mixing, it is the most efficient of the studied systems, both with respect to cost and technical outcome.

### References

Värmeforsk RAPPORT 954, Energiforsk RAPPORT 2016:264 , Värmeforsk Rapport 1101

## 2.2 Strain measurement of gravel road with loaded HCT-vehicle combination

*Mauri Haataja*<sup>\*1</sup>, *Veikko Pekkala*<sup>1</sup>

<sup>1</sup>University of Oulu

*\*Corresponding author: Mauri.Haataja@oulu.fi*

**Keyword:** Road strain, timber transport vehicle combination

### Abstract

Improving the long term management of climate change requires a significant reduction in greenhouse gas (CO<sub>2</sub>) emissions in heavy vehicle transport. Transport efficiency has been significantly increased with the application of HCT vehicle combinations on Finnish roads since 2013. Permissssions of the HCT –vehicle combinations has been granted for 93 vehicle combinations, most of which have a maximum total mass of 76 tonnes, longer and heavier than 76 tonnes of 20 vehicle combinations. (Traficom). The loadability of the road routes varies considerably depending on the quality level of the road as well as an upper and lower quality. The target was to study of heavy vehicle combinations with different axle systems on gravel roads with different subsoil.

During 2018, road traffic measurements were carried out in Jaatila, Northern Finland, about 40 kilometers to south from Rovaniemi. The measurements were focused on two separate measuring lines of approximately 400 meters in length, one of which was peat ground and the other was moraine ground. The mean of the total load (E<sub>2</sub>) on the peat ground measurement line was about 100 MN/m<sup>2</sup> and on the moraine ground measurement line 150 MN/m<sup>2</sup>. The main goal was to find out the influence of different axle systems in vehicle combination and to study of wheel's lines influence on road strain. In addition, of the target was to find out whether the measurement of the gravel routes can be utilized to create a prediction of gravel routes damage or rutting with the different numbers of axles in vehicle combinations.

## 2.3 Development of collection and utilisation of private road data

Pirjo Venäläinen\*<sup>1</sup>

<sup>1</sup>Metsäteho Oy

\*Corresponding author: [pirjo.venalainen@metsateho.fi](mailto:pirjo.venalainen@metsateho.fi)

### Keyword:

### Background

Private roads cover approximately 75% of the total road network in Finland. Accurate and timely private road data is required for establishing efficient and safe timber transportation and road maintenance operations (especially in winter and thawing periods). The climate change increases the urgency to develop weather and forecast models for gravel roads. New technologies in road data collection (see Figure 1) are being tested and developed in various projects in Finland.

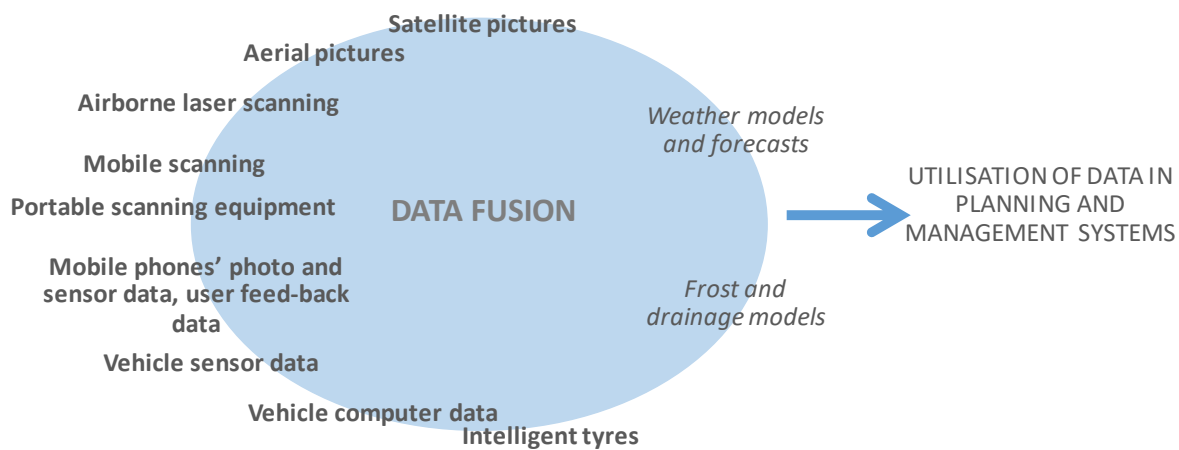

Figure 1. Technologies for road data collection (Venäläinen et al. 2019a).

### Projects on private road data

Efficient use of private road data collected by different actors (including crowd sourcing) and with various methodologies require data platforms that fuse, enrich, filter, and distribute data for specific end user applications. Establishing such data platform demands new types of collaborations between several public and private actors (authorities in road and data issues, data producers and users, technology developers, and research institutions).

The ongoing project financed by the Ministry of Agriculture and Forestry of Finland sets preliminary vision together with technical specifications for a private road data platform (Venäläinen et al. 2019b). Discussions with stakeholders regarding the organisation, finance and implementation of the platform will take place later this year.

It is necessary to apply new types of tools and collaborative models to ensure comprehensive data collection in the case of private road network. One potential method is to use mobile phones in the collection of video and sensor data that may be analysed with automated machine vision and sensor analysis tools (Figure 2). Pilot testing (for example Venäläinen et al 2017) of such tools has yielded promising results already.

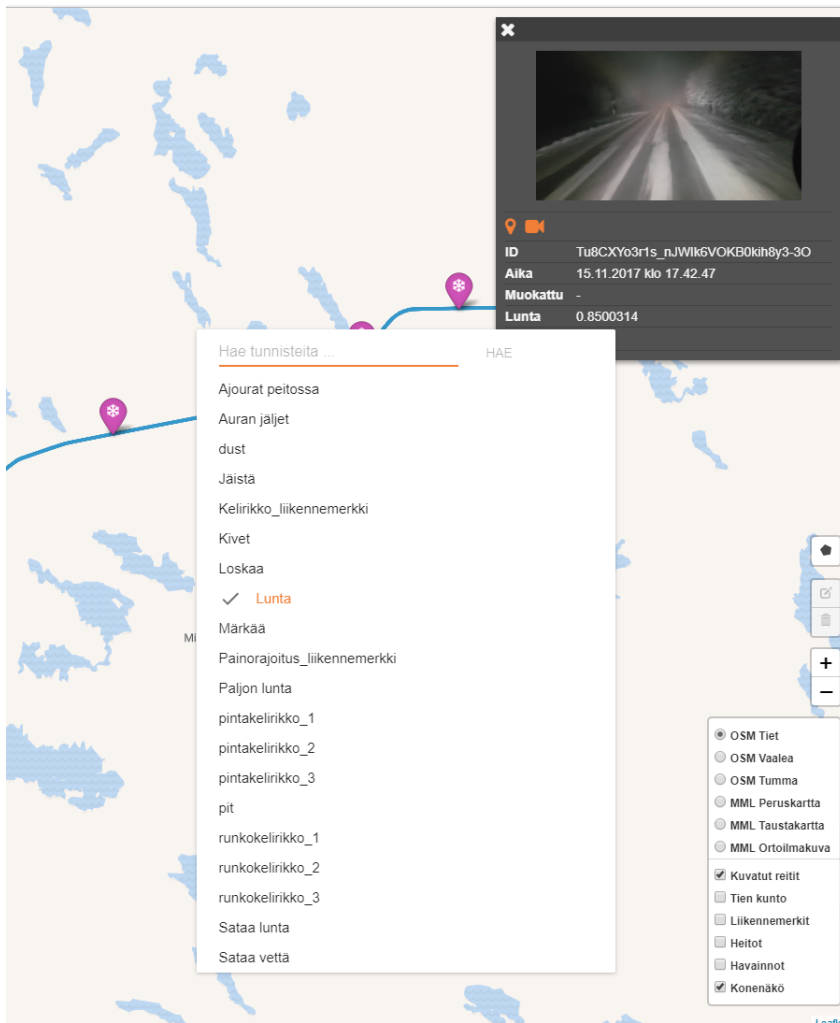

Figure 2. Machine vision identification of snow on a road (Venäläinen et al. 2017).

## References

- Venäläinen, P., Niskanen, S., Vahtila, M. & Räsänen, T. (2019a) Yksityistietiedon tietolajit ja tiedonkeruumenetelmät. Metsäteho Report 249.
- Venäläinen, P., Räsänen, T. & Niskanen, S. (2019b) Yksityistietiedon palvelualusta - Visio & organisointi. Metsäteho Slide Series 2/2019.
- Venäläinen, P., Raatevaara, A., Pihlajisto, I., Melander, M., Hienonen, P., Hämäläinen, J. & Strandström, M. (2017) Tilannekuva ja automatisoitu tiedontuotanto metsäsektorin kuljetuksista. Metsäteho Report 244.

## 2.4 Calculation model for transport capacity for timber trucks - development of the decision support system NETRA

*Permångs M.<sup>1</sup>, Edlund B.<sup>1</sup>, Bergström D.<sup>1\*</sup>*

<sup>1</sup>Swedish University of Agricultural Sciences, Department of Forest Biomaterials and Technology, Skogsmarksgränd, 901 83 Umeå, Sweden

*\*Corresponding Author: dan.bergstrom@slu.se*

### **Keyword:**

### **Abstract**

When using transport optimization to maximize the economic net for the destination of wood from wood source to wood receiver, the transport distance is not necessarily minimized. This then, for example the recipient's price can control wood transactions for longer transports. Depending on the business model, the destination of wood for different recipients can change the transport distance. Since the transport distance affects the need for transport output, it is important to know how the wood businesses affect the transport need in the destination of wood.

The purpose of this study was therefore to develop a transport capacity model to implement in the Norra Skogsägarna's decision support system NETRA (NEgotiation and TRANsport planning model). This is to be able to compare the transport needs and the transport capacity with different optimization proposals. NETRA is developed in Microsoft Excel.

The transport capacity model's calculations are based on volumes and average transport distances from optimization proposals, user input on the number of trucks, shifts and the geographical scope of the trucks. The results of the transport capacity model are visualized in a created map function in Excel to quickly give the user an idea of whether there is over or under capacity in any geographical area or at a specific haulage company.

The developed transport capacity model overestimates the transport capacity on average per week and car by 5.4%, which according to Norra Skogsägarna is a reasonable level for this type of decision support. The new study with NETRA has, through the addition of the transport capacity function, created opportunities for Norra Skogsägarna to calculate the need for transport capacity that can be compared with available transport capacity.



## 2.5 A method of finding HCT corridors

Höök C.<sup>1\*</sup>, Asmoarp V.<sup>2</sup>, Edlund B.<sup>1</sup>, Bergström D.<sup>1</sup>

<sup>1</sup>Swedish University of Agricultural Sciences, Department of Forest Biomaterials and Technology, Skogsmarksgränd, 901 83 Umeå, Sweden, <sup>2</sup>Skogforsk, The Forestry Research Institute of Sweden, 751 83 Uppsala Sweden

\*Corresponding Author: [cnho0001@stud.slu.se](mailto:cnho0001@stud.slu.se)

### Keyword:

### Background

In Sweden, 71.6 million (M) tonnes (t) of forest biomass were during 2016 transported by truck, corresponding to approximately 15 % of all national goods truck transport (Davidsson & Asmoarp, 2019). To reduce the environmental impact of forest product transports and meet Swedish climate goals, the use of 90-tonne high capacity transport (HCT) trucks has been identified as one potential measure to reduce impact. An HCT vehicle, with a gross weight of 90 tonnes (cargo net weight of ca 61 t) and a length of 30 meters including a truck, dolly, link and trailer dividing the weight to 11 axels, has been tested (Fogdestam & Löfroth, 2015). This configuration allows the HCT truck to carry four piles of roundwood compared to a conventional truck set which carries three. Fuel consumption of the HCT truck is increased due to its higher gross weight, but by carrying more roundwood every turn, the consumption per net weight is reduced (Widinghoff, 2014).

Previous studies concludes that the use of HCT trucks is environmentally and economically beneficial on apposite routes but that casual use of HCT would increase costs and greenhouse gas (GHG) emissions and could also displace transport from train to trucks, further canceling potential GHG reduction (Haraldsson et al, 2012; Näslund, 2017; Lööf, 2015; Adell et al, 2016). Thus, it is of great importance to consider several factors with a holistic approach when designing roundwood truck fleets consisting of HCT trucks. Currently, there are no general methods developed of which potential HCT routes can be identified.

The objective was therefore to develop a method of finding the geographical occurrence of potential roundwood HCT corridors for 90-t trucks, as well as estimating their environmental and economic potentials in comparison to the conventional 74-t truck transport system for Swedish conditions. We here present preliminary results.

### Method design

This study used data about actually performed transports of forest biomass during 2016. The dataset was collected by SDC (Swedish Data Central, now Biometria) and was comprised of information including, but not limited to, geographical origin, destination, assortment and cargo weight for each roundwood transport. To supplement, the forest industry version of the Swedish national road database (SNVDB) was used. SNVDB is a georeferenced digitized road network carrying information about road class, speed limit, and other road characteristics. Every link in the road network has a resistance attribute, a single value to describe the road's suitability for use in a route. The method used ArcGIS Pro 2.3, Python 3.7 and a calibrated route finder (CRF) (Svensson, 2017) developed by Skogforsk and SDC. The CRF provided the ability to route transports between nodes with regards to lowest resistance on the road network and outputted distance, time- and fuel consumption.

First, all network links in the SNVDB with a road class potentially able to support a 90-t HCT vehicle was selected as a technically supportive network. The technically supportive network was then combined with flow information from the transport history dataset to produce a flow supportive network, holding all technically supportive links with a transport flow above a flow threshold. This threshold was based on the minimal transport flow needed to establish a corridor for continuous HCT traffic and was a measure of the

desired resolution of the analysis, where a higher threshold would include fewer road links but with a more substantial roundwood flow. With a lower threshold, in the event of adjacent corridors, a single HCT truck could be apportioned. Cohesive road links were then aggregated into flow supported corridors with terminal nodes placed at each end.

The CRF was then used to route all transports originating from within a desired buffer distance from the terminal nodes in two configurations. The first was the least resistance path from the landing to the receiver using conventional truck transport while the second configuration was routed from the landing to the receiver via the HCT-corridor (Figure 1). In both cases, the model's reach was limited to transports where both the landing and the receiver was placed within either of the buffer areas around the corridor's terminals. The two configurations were compared in terms of fuel consumption and cost.

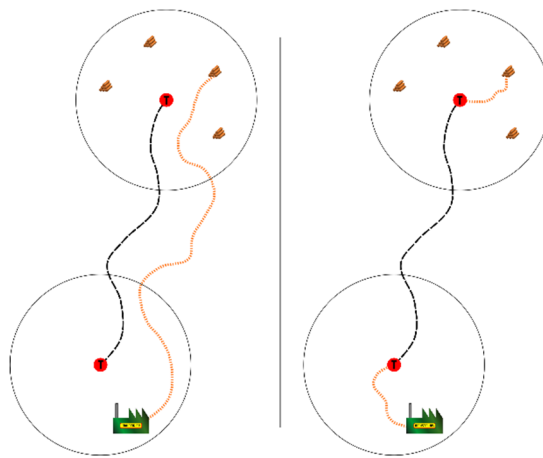

Figure 1. Schematic illustration of direct routing (left) and routing via corridor (right).

## Preliminary results

Interpretation of the preliminary results suggested that there were 25 corridors throughout Sweden, with a higher occurrence in coastal areas (Figure 2). Each one of these corridors provided a flow threshold of at least one HCT transport every three days. A radius of 50 km (Euclidean) around terminals was used as buffer distance.



Figure 2 Identified 90-t HCT corridors in Sweden.

The mean length of the corridors was about 69 km with shortest and longest being 15.9 km and 115.3 km respectively. Of the 3823 Mtkm transport work carried out within the area around the corridor's endpoints, 48% were viable for analysis, having the receiver within reach of the model. In 17% of this 48% transport work, the haulage of 2.5 Mt of roundwood were indicative of being more environmental and economical beneficent if routed via the HCT corridors, thus saving 5200 tCO<sub>2</sub> and €3.1M in fuel costs. Terminal handling and depreciation costs of terminal establishment were calculated to €1.8M.

## Conclusions

With current regulatory practices where special permits is needed to deploy trucks heavier than 74-t, the use of 90-t HCT corridors is limited to specific use cases and roads with a constant flow of assortment-homogenous roundwood, such as between a rail terminal and industry or a big consolidated procurement area and a mill or heating plant. This tendency has also been suggested in previous studies (Korpinen *et al.*, 2019). A more supple regulatory framework together with a flexible terminal solution (such as using modular pallet systems or using turning areas as temporary terminals) would enable the corridors to move with the demand, further unlocking GHG- and cost-reducing potential.

Since some of the 90-t HCT corridors were quite close to each other it could be an even higher benefit to redesign the corridors so they can use the same terminal and HCT trucks.

Preliminary results suggested that 90-t roundwood trucks would be GHG- and cost-beneficial compared to 74-t trucks when used on apposite routes. It should also be noted that the majority of roundwood transports in Sweden today are using 64-t trucks, making the real potential in saving GHG and costs on identified 90-t HCT corridors higher than suggested in this study. The preliminary results were limited to fuel and terminal handling and establishment as cost items and did not account for any potential savings in labour due to the overall reduction in vehicle kilometres or any cost related to upgrading the transport fleet.

## References

- Adell, E., Khan, J., Hiselius, L., Lund, E., Nelldal, B.-L., Pettersson, F., Pålsson, H., Smidfelt Rosqvist, L. & Wandel, S. (2016). *Systemanalys av införande av HCT på väg i Sverige*. (Rapport nr.95. Lund: Miljö- och energisystem, LTH, Lunds universitet.
- Davidsson, A. & Asmoarp, V. (2019). *Forestry road transports 2016*. (Arbetsrapport 1007-2019. Uppsala: Skogforsk.
- Fogdestam, N. & Löfroth, C. (2015). *Slutrapport, demonstration av ETT- och ST-fordon*. (Arbetsrapport 872-2015. Uppsala: Skogforsk.
- Haraldsson, M., Jonsson, L., Karlsson, R., Vierth, I., Yahya, M.-R. & Ögren, M. (2012). *Samhällsekonomisk analys av rundvirkestransporter med 90-tonslastbilar*. (Rapport 758. Linköping: VTI.
- Korpinen, O.-J., Aalto, M., Venäläinen, P. & Ranta, T. (2019). Impacts of a High-Capacity Truck Transportation System on the Economy and Traffic Intensity of Pulpwood Supply in Southeast Finland. *Croatian Journal of Forest Engineering*, 40(1), pp. 89-105.
- Lööf, M. (2015). *En systemanalys av tyngre lastbilars påverkan på tågtransporter*. Diss. Uppsala: Sveriges Lantbruksuniversitet.
- Näslund, R. (2017). *Ruttanalys av en tvådelad fordonsflotta bestående av HCT och konventionella rundvirkeslastbilar*. Diss. Umeå: Sveriges Lantbruksuniversitet.
- Svensson, G. (2017). *Optimized Route Selection for Logging Trucks*. Diss. Umeå: Sveriges Lantbruksuniversitet.
- Widinghoff (2014). *Kontinuerlig uppföljning av drivmedelsförbrukning och lastfyllnadsgrad för ETT- och ST-fordon*. (Arbetsrapport 831-2014. Uppsala: Skogforsk.

## 2.6 New Finnish truck regulations may change the supply chain of forest fuels

*Harri Ruokojärvi<sup>1</sup>, Pirjo Venäläinen<sup>2</sup>, Asko Poikela<sup>2</sup>, Veli-Pekka Kivinen<sup>1</sup>, Bo Dahlin<sup>1\*</sup>*

<sup>1</sup>University of Helsinki, Finland, <sup>2</sup>Metsäteho, Finland

*\*Corresponding author: bo.dahlin@helsinki.fi*

**Keyword:** Transport, timber truck, legislation

### Abstract

In Finland some 8 million solid cubic meters of forest fuels are harvested every year. The most common supply chain is to extract the wood to roadside and to chip it at the landing. The road transport is then made by chip trucks to final user. New Finnish truck regulations (from 21.1.2019) is increasing the maximum allowable length from 25,25 m to 34 m while keeping the maximum gross vehicle weight at 76 tonnes (same as before). This may present a possibility to improve the economy of transporting very bulky (but light) material, as uncomminuted forest fuels. We investigate how these new trucks may affect the supply chain for different types of forest fuels and the optimal location for comminution.



## 3 Mitigating Site Impact



### 3.1 The effects of an extra axle on forwarder wheel rut development

*Øivind Østby-Berntsen<sup>1</sup>, Dag Fjeld<sup>\*2</sup>*

<sup>1</sup>Norskog, <sup>2</sup>Norwegian institute for bioeconomy research

*Corresponding author: dag.fjeld@nibio.no*

**Keyword:** forest operations, undercarriage, soil moisture content

#### Abstract

The goal of this study was to compare wheel-rut development between a conventional 8-wheel forwarder and a 10-wheel forwarder. Two Ponsse Buffalo forwarders with 14t load capacity were compared; one with a standard double-bogie undercarriage and one with double-bogie axles plus an additional back axle. The comparison was set up with two parallel forwarding trails over marine sediments (sand) leading from the landing down to four strip roads over a 4 m deep bog. A sample of 7 blocks with 3 transects per block were laid out to follow the compression of the harvest residue layer (above humus surface) or development of rut depth (below humus surface) after each pass. Ruts deeper than 10 cm were found on 19 and 31 % of transects after 5-10 and 15-20 loads for the 8-wheeler. The corresponding figures for the 10-wheeler were 7 and 12 %, respectively. Using linear regression, 79 % of the variation between transects could be explained by load interval, forwarder and pre-harvest soil moisture content



## 3.2 The OnTrack forwarder – results and experiences from constructing and testing a rubber-tracked forwarder with low ground pressure

Talbot, B.<sup>1\*</sup>, Björheden, R.<sup>2</sup>, Poikela, A.<sup>3</sup>, Lazdiņš, A.<sup>4</sup>, Kopetzky, M.<sup>5</sup>

<sup>1</sup>Norwegian Institute for Bioeconomy Research, NIBIO, <sup>2</sup>Forestry Research Institute of Sweden, Skogforsk, <sup>3</sup>Metsäteho Oy, <sup>4</sup>Latvian State Forest Research Institute, SILAVA, <sup>5</sup>Kuratorium für Waldarbeit und Forsttechnik, KWF

\*Corresponding author: [bta@nibio.no](mailto:bta@nibio.no)

**Keyword:** logging, compaction, soils, productivity, forwarding, extraction

### Background

The H2020 OnTrack project had the goal of developing and testing a full size commercial forwarder with low ground pressure. The motivation for this was the apparent change in climatic conditions in northern Europe where the periods of mild and wet weather seem to be increasing and the period of stable, cold weather where a machine is able to traverse almost any soil type, appear to be receding, leaving a period of uncertain trafficability. The main industrial partners in the project consortium included original equipment manufacturers (OEMs) Ponsse Oy and Prinoth SpA, who had responsibility for the chassis and undercarriage respectively, supported by Owren AS in Norway, and Konsthöjden in Sweden. One central constraint imposed by the OEMs was that the machine would be constructed using off-the-shelf components as far as possible. Forest Research Institutes Skogforsk (SE), SILAVA (LV), Metsäteho (FI), KWF (DE) and NIBIO (NO) were engaged in testing the machine in forest environments in their respective countries. The project period was 24 months, of which just over 6 months were used in constructing the machine and the remainder used for testing and modification. This presentation will highlight the major design and performance factors arrived at during the project.

### Material and Methods

Firstly, the operational environment for a machine of similar design characteristics was mapped in each country using the national terrain classification system. Assumptions were made on the speed the machine might travel, and what kind of payload it might carry on five different categories of ground strength, ground roughness and slope. These were used in a comparison with conventional machines, based on generalised figures, in order to estimate the extent of the areas where the proposed machine would be equivalent or better than standard forwarders.

The OnTrack machine was constructed on the chassis of a 14 tonne, long wheel-base Ponsse Buffalo forwarder. Construction involved replacing all bogie axles with specially constructed carrier beams including drive sprockets, idler wheels and castor wheels for carrying two models of Prinoth's steel reinforced rubber belts. The drive sprockets were chain driven. Various configurations of carrier beam rigidity were tested in a simulation, and two of these tested in the field. Ground contact areas for each front belt were 2700 x 700 mm while for the rear belts they were 3600 mm x 750 mm.

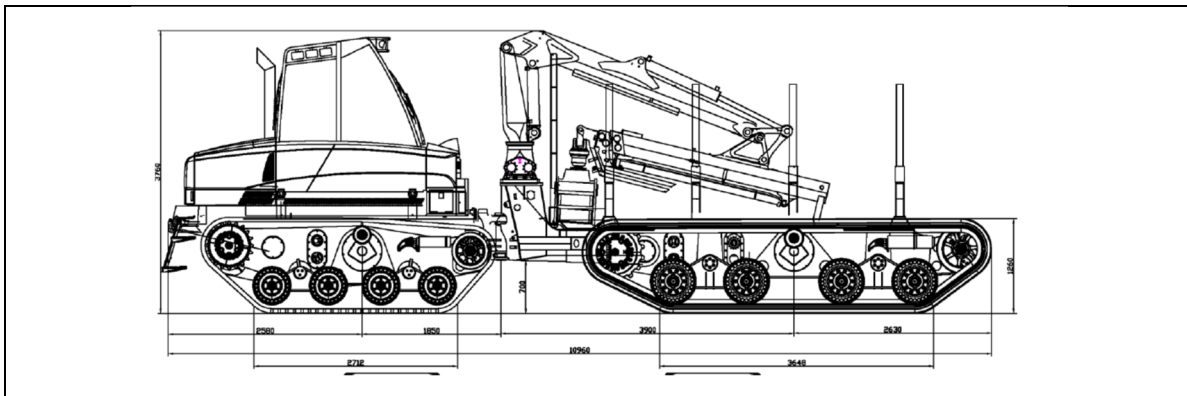

Figure 1. Schematics of the OnTrack forwarder (Ponsse).

The machine was tested in different working conditions in each participating country. In Sweden, Skogforsk carried out the initial testing on the standardised test track in Jälla. This track primarily tests vehicle reaction to surface roughness. The machine was further tested in operational conditions where it extracted over 4000 m<sup>3</sup> in early summer conditions. As a result of this intermediate testing, further modification was necessary, including installing valves to allow for the tensioning cylinders to act individually, rubber bushings were installed to reduce impact when the carrier beams reached the end of their area of play, hydraulic cylinders were installed to dampen the oscillation of the track beams, the rear track beams were freed up to oscillate like normal bogie axles, and these were reinforced against excessive lateral forces during turning by installing running stabilizers in the front and rear of the beams.



Figure 2. The constructed machine traversing Skogforsk's vibration test track (photo: Rolf Björheden).

Further field testing included a comparative study carried out on soft organogenic soils. This test involved replications driving with and without load, both in a straight line and on a slalom track. The machine was compared against two other configurations of the Ponsse Buffalo simultaneously, a Buffalo 8-wheeler, and a Buffalo 10-wheeler, tested with and without steel tracks.

The machine was then tested in operational conditions for roughly one month in each country; In Latvia it operated under record wet conditions on sandy soils, in Finland it worked in deep snow conditions, in Germany it worked mostly in dry conditions on soils of good strength (due to hot and dry summer) while in Norway, it was put to work on steep slopes. In addition to normal operational work, the forest research institute of each country put the machine through various tests. Fuel consumption, number and cause of track de-railings, and track wear and tear were some of the most important variables monitored. A second set of tracks modified for forestry conditions was manufactured during the project and replaced the original standard tracks.

## Results and discussion

Generally, the machine performed well and better than all expectations. The overall machine mass ended higher than originally intended, however a number of opportunities were identified for significantly reducing this in an eventual follow-up model. In spite of this, ground pressure was under 50 kPa and the machine easily outperformed comparative machines in terms of rutting depth on soft soils. Challenges faced include the avoidance of de-railings, both mechanically and through changed operating practices. The change of tracks meant that a sufficient number of hours were not logged on each track set to evaluate longer term track wear. Specific results on performance (driving speeds, vibration, fuel consumption) and experiences gained are provided in the presentation.



Figure 3. The machine on site during international field testing, here in Germany

## Acknowledgments

The authorship of this abstract includes only a single representative of each forest research institute involved. The authors wish to acknowledge the considerable inputs of all project participants, especially those of the OEMs Ponsse Oy and Prinoth SpA, and project coordination team led by Rasmus Astrup (NIBIO). This work was funded through OnTrack, a project that received funding from the European Union's Horizon 2020 research and innovation programme under grant agreement No. 728029. Project partners included industry; Ponsse Oy (FI), Prinoth SpA (IT), Konstholmen (SE) and Owren SA (NO), as well as forest research institutes Skogforsk (SE), Metsätöho (FI), SILAVA (LT), KWF (DE) and NIBIO (NO). Project website <https://cordis.europa.eu/project/rcn/205660/factsheet/en>

### 3.3 Identification of wet areas using airborne LiDAR data

Ivanovs Janis<sup>\*1</sup>, Lupikis Ainars<sup>1</sup>, Karklina Ilze<sup>1</sup>

<sup>1</sup>Latvian State Forest Research Institute “Silava”

*\*Corresponding author: janis.ivanovs@silava.lv*

**Keyword:** Remote sensing, trafficability

#### Abstract

The aim of the study is to evaluate the possibilities of applying LiDAR (*light detecting and ranging*) data in wet area mapping in forest on mineral soils. The research area was chosen to represent different types of Quaternary geological deposits. A total of 228 sample plots in different forest stands were selected. Data about soil characteristics like thickness of peat layer and presence of reductimorphic colors in soil was collected during field surveys.

In addition to this work, the analysis of the impact of seasonal streams in four mature forest stands on different types of quaternary geological sediments was performed. Catchment area size maps have been developed for forest stands, where each raster cell represents the number of raster cells in its relief, from which the surface water runoff occurs through this particular cell. Temporal water table changes has been measured at locations of seasonal streams.

The study concludes that the developed soil moisture maps can be used to locate swampy and locally wet areas. However, at the level of forest stands the relative spatial distribution of soil moisture has to be improved, as the depth and soil penetration resistance data did not provide a reliable relationship with the soil moisture forecast.

It is also concluded that the size of the catchment area influences the formation of seasonal currents and that these sites can be localized. It has been observed that the water table level is higher in the bed of seasonal currents and water table falls slower than in adjacent areas.

### 3.4 Registration of wheel rutting and ground condition class in Danish forestry using high resolution LiDAR data and digital legacy maps

Ingeborg Callesen<sup>\*1</sup>, Bo Brockmann<sup>2</sup>, Lene Fischer<sup>2</sup>

<sup>1</sup>University of Copenhagen, Department of Geosciences and Natural Resource Management, Section for Forest, Nature and Biomass, Rolighedsvej 23, 1958 Frederiksberg C, <sup>2</sup>Forest and Landscape College, Nødebovej 77, 3480 Fredensborg

*\*Corresponding author: ica@ign.ku.dk*

**Keyword:** Site impact, soil, logging, harvesting

#### Abstract

Wheel tracks in forests can be registered using high-resolution digital elevation models (DEM's) that are becoming increasingly available throughout the world. In Denmark, the most recent nationwide point cloud data were scanned by airborne laser scanning (ALS) in 2014-15. A 4-5 year production cycle for the LiDAR data is projected by the Danish Ministry of Energy, Utilities and Climate. This will allow for repeated monitoring of tracks on permanent forest plots in the National Forest Inventory.

Here, wheel tracks were assessed visually on 400 square 50 x 50 meter plots around permanent soil monitoring sites within the National Forest Inventory. Hill-shaded DEM raster datasets (2014-15) with 40 cm pixel size were classified in four abundance classes for wheel track prevalence (frequency in parentheses): 0 – no tracks or hardly visible tracks (34%), 1 – plot intersected by one main track (47%), 2 – main and side tracks (13%), 3 – main tracks and abundant side tracks (5%). A share of 26% of the DEM's had too few ground points to produce a detailed DEM due to a dense cover of tree crowns. Tracks were visible on such sites as the wheel tracks could still be reached by the ALS. Line-shaped patterns of plowing or mechanical weeding in rows were visible on 30% of the sites.

Ground condition classes for forest operations were mapped from open data. These were DEM's and topographical depressions (bluespots), slope, modeled ground water depth and a parent material map. Wheel tracks were most abundant in the ground condition classes 'poor' and 'very poor'. Forest machine operators can predict and avoid poor (wet) ground conditions during machine operations by using such maps and recent climate data. This gives an option for preserving the soil quality for tree growth. Soil deformation and soil compaction can be reduced by planning.

### 3.5 Real time measuring and mapping of soil disturbance

Astrup, R<sup>1</sup>, Nowell, T<sup>\*1</sup>, Talbot, B.<sup>+1</sup>

<sup>1</sup>Norwegian Institute for Bioeconomy Research, NIBIO

\* *Presenter*

<sup>+</sup>*Corresponding author: bta@nibio.no*

**Keyword:** harvesting, rutting, compaction, detection

#### Background

Over 400 million m<sup>3</sup> of timber are harvested for industrial purposes annually in Europe, almost all of which is extracted by machines. Using a generalised estimate of 100 m<sup>3</sup> per hectare extracted on average between thinning and final felling operations, and given that around 15% of the site might actually be driven on, this implies that roughly 500 000 hectares of forest land is directly impacted annually by forest machines. This presentation reports on the development and testing of a fully integrated wheel rut scanning and monitoring system that could be used in tracing any impact on the soil caused by forest machines. The system was constructed and tested on the OnTrack forwarder for a period of approximately 12 months. The basic system design, functionality, reporting formats and some of the practical experiences gained are reported here.

#### Material and Methods

As the project focus was on developing a system with real commercial implementation potential, an important constraint in the design was to keep the cost as low as possible. The system incorporated 4 low cost LiDAR units (6 m effective range) integrated into steel housings located on each corner of the machine. Each corner unit further included an IMU and a Raspberry Pi® processor, wired through a LAN to a central processing unit. The scanners were set up such that the difference in rut depth in the direction of machine movement could be calculated per pass. An RTK GNSS (SwiftNav Piksi) unit provided high precision localisation data when used in connection with a base station, good localisation data on clearcuts, and reasonable localisation data when used under forest canopy. In the latter case, reporting was carried out in a coarser 10 m x 10 m resolution heatmap. A screen in the cabin indicated whether each of the scanners was functioning correctly, informing the operator if any of the scanning windows were not fully transparent. Finally, a router was installed via which data was uploaded to the cloud for real time processing and mapping. Efforts were made to ensure that the units could work effectively through a range of climatic conditions.

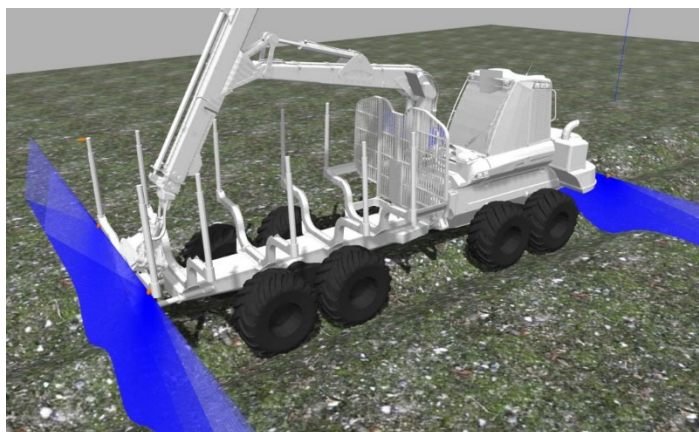

Figure 1. Conceptual diagram showing how the system was envisaged to function.

## Results and discussion

Initial challenges to the functioning were primarily related to the wiring and the weatherproofing of the steel housings. Direct moisture, condensation and cold conditions (<10 degrees C) led to problems with some of the sensors, especially in returning too few LiDAR points. While the steel housings were sufficiently robust, they were exposed to considerable forces when driven against trees and in a number of cases the mountings were bent to an extent where the scans were pairs of LiDARS were no longer scanning in the same plane. Water in wheel ruts does not return a LiDAR response, although this did not prove overly problematic as in many cases any water is displaced long enough for the scan. Excessive harvesting slash makes it difficult to define the soil surface, although with multiple passes, the slash is often compacted enough to represent this sufficiently. The on-board camera proved to be a useful tool for verifying the actual status of the wheel ruts. Further insights into the results achieved, as well as those from a backpack version of the same tool will be provided.

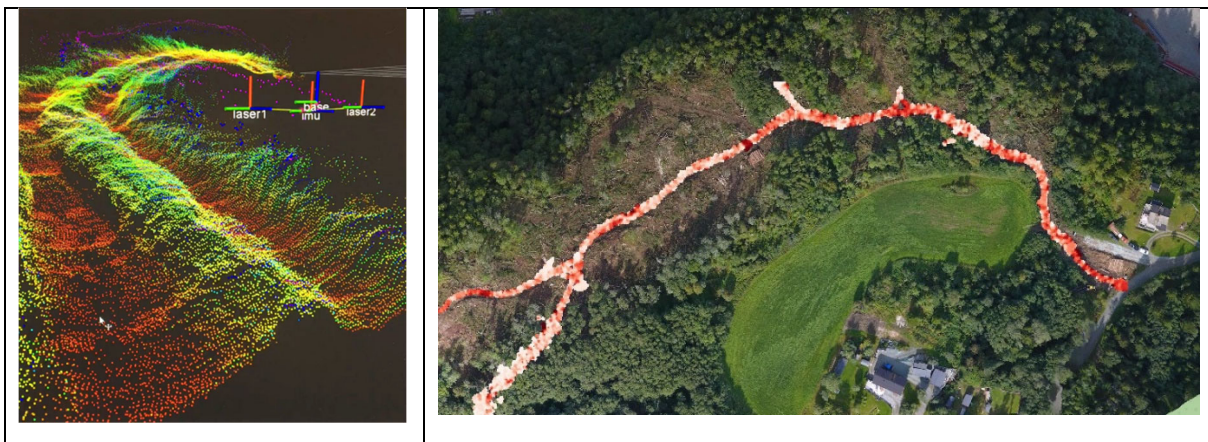

Figure 2. Wheel rut data from an individual high precision scan (left) and heatmap indicating areas of different rutting depths at a stand level (right)

## Acknowledgments

This work was funded through OnTrack, a project that received funding from the European Union's Horizon 2020 research and innovation programme under grant agreement No. 728029. Project partners included industry; Ponsse Oy (FI), Prinoth SpA (IT), Konstholmen (SE) and Owren SA (NO), as well as forest research institutes Skogforsk (SE), Metsatöho (FI), SILAVA (LT), KWF (DE) and NIBIO (NO). Project website <https://cordis.europa.eu/project/rcn/205660/factsheet/en>. The authors acknowledge the inputs of PhD Marek Pierzchała and all project partners for assistance in keeping the monitor functional during international field testing.

### 3.6 Bearing capacity measurements during forest roads maintenance and construction, praxis in JSC Latvia's State Forests

Nora Sukite\*<sup>1</sup>

<sup>1</sup>JSC Latvia's State Forests

\*Corresponding author: [n.sukite@lvm.lv](mailto:n.sukite@lvm.lv)

#### **Keyword:**

#### **Abstract**

Forest infrastructure department in JSC Latvia's State Forests was founded in 2006. Before that forest roads were built in a simple way determining only the min and max percentage of clay in gravel top layer material. Later as transport loads were getting higher and more intense some roads started to show insufficient bearing capacity. As a forest infrastructure quality and control department we started to explore the necessary quality requirements for materials used for construction and control tools while road construction.

Since 2009 we found two most effective tools which are: 1. Requirements for sand, gravel geometrical properties and percentage of shells in coarse aggregates, filtration 2. Bearing capacity and compaction level measurements with light drop weight testers. These two methods show the most reliable results to designed bearing capacity according to low volume but high bearing capacity roads.

The light drop-weight tester (all data and praxis gained using Zorn ZFG 02 and 03 models) is used to inspect subgrade and granular base layers during road construction as a quick method to evaluate the dynamic deflection modulus  $E_{vd}$  in MN/m<sup>2</sup>. This tester is especially suitable for testing coarse grained and mixed grained soil up to a maximum size of 63 mm in diameter.

Forest road construction requirements (JSC Latvia's State Forests) define the compaction level  $E_{v2}/E_{v1}$  for subgrade layers, bearing capacity  $E_{vd}$  for sand base layer and  $E_{vd}$  for gravel top layer. Defined values show exact correlation between required geometrical properties of materials, compaction level and achieved bearing capacity which allows to ensure high quality roads for further timber transportations.





## 4 Remote sensing and computer vision



## 4.1 Mapping forest attributes using accurately positioned tree-level harvester data and airborne laser scanning

Endre Hansen<sup>\*1,2</sup>, Marius Hauglin<sup>2,3</sup>, Matti Maltamo<sup>4</sup>, Terje Gobakken<sup>2</sup>, Erik Næsset<sup>2</sup>

<sup>1</sup>Norwegian Forestry Extension Institute, <sup>2</sup>Faculty of Environmental Sciences and Natural Resource Management, Norwegian University of Life Sciences, <sup>3</sup>Norwegian Institute of Bioeconomy Research, <sup>4</sup>School of Forest Sciences, University of Eastern Finland

*\*Corresponding author: eh@skogkurs.no*

**Keyword:** GNSS, harvesting, remote sensing

### Abstract

Forest management maps containing stand attributes, such as basal area, number of stems, and merchantable volumes by species, enable the forest owner to make informed decisions regarding the management of the forest. These stand attributes are usually estimated from remotely sensed data. Typically, airborne laser scanning (ALS), covering the area of interest, is combined with manually registered field reference data, and the relationship used to predict attributes at plot-level. The cost of collecting the field reference data often represents a substantial part of the total inventory cost. As a low-cost alternative use of data collected by the harvester during a mechanized harvest operation has been suggested. Harvesters collect measurements such as diameter at breast height and log lengths, and tree species is registered manually by the operator. This means that the data registered by the harvester corresponds to the measurements collected manually as field reference data in field plot inventories. Data collected by the harvester will, of course, be restricted to areas where the harvester operates—usually mature forest and clear-cut areas. Furthermore, trees within the clear-cut area which are not cut will result in systematic errors. Additionally, errors in tree positions will cause a mismatch between ALS and harvester data. Despite these apparent shortcomings, the results from two studies show a close relationship between ALS and harvester data, indicating the suitability of harvester data to predict stand attributes of mature stands.

## 4.2 Possibilities of automatic quality measurement in wood harvesting

Heikki Ovaskainen<sup>1</sup>\*

<sup>1</sup>Metsäteho Ltd

\*Corresponding author: [heikki.ovaskainen@metsateho.fi](mailto:heikki.ovaskainen@metsateho.fi)

**Keyword:** quality information, automatic data measurement, sensors, harvester, camera, laser

### Abstract

In Finland, the future goal of timber harvesting quality measurement is that the quality information describing the post-harvest situation on the thinning area would be collected automatically during the harvesting work. Automatic measurement, processing and utilization of the quality data related to the tree and soil characteristics of the harvesting area would be enabled during the work. The information could be shared and reported for various purposes. Another key objective of the automated harvesting quality information collecting system is to update forest resource data to describe the post-harvest situation on the stand. The information produced by the system is utilized immediately to self-monitoring during the work, but the accumulating quality information can also be utilized as a general quality statistics and data repository for forest work, especially for tree characteristics, as an update of forest resource data and as reference material, for example, calibration and development of terrain trafficability predictions. A key to the automatic quality information is that the harvester operators would not need to use too much or at all time for data collecting and storing. Another benefit of this kind of automation would be that the need of systematic manual data collecting in forest decreases.

The aim of this study was to examine how different measurements and sensor technologies can detect traditional thinning quality variables, most of which have so far been measured manually. The results indicated that it is possible to obtain a measurement observation from all quality variables in overall. The detection of some variables, such as stem damages, necessarily requires additional sensors (cameras, lasers) in forest machines.

The general aim is to minimize the number of electronical sensors to be attached to forest machines; sensors are sensitive to failure in demanding forest conditions. Thus, one perspective in this report was to estimate if the quality data could be generated directly or indirectly by using the existing forest machine sensor data. As a result, all quality variables cannot be measured, observed or estimated reliably with current machine sensors, although most of the quality variables are measurable or derivable from other variables with a sufficient accuracy. This study summarizes how well the quality information could be produced with existing sensors.

### For further information:

Ovaskainen, H. (ed.) (2019) Kohti automaattista puunkorjuun laadun mittaamista. Metsätehon raportti 251. [In eng. Towards automatic quality measurement in wood harvesting] Metsäteho's report. 51 p.

## 4.3 Detecting stem damage by applying machine vision

Kalle Kärhä\*, Jyry Eronen<sup>2,3</sup>, Teijo Palander<sup>3</sup>, Heikki Ovaskainen<sup>4</sup>

<sup>1</sup>Stora Enso Wood Supply Finland, <sup>2</sup>Karelia University of Applied Sciences, <sup>3</sup>University of Eastern Finland, <sup>4</sup>Metsäteho Ltd

\*Corresponding author: [kalle.karha@storaenso.com](mailto:kalle.karha@storaenso.com)

### Keyword:

### Background

In Finland, the target is that in the future, the measurement and monitoring of thinning work quality will be extensively automated. In the near future, when stem damage is automatically measured and monitored in thinnings, it is likely that it will be carried out with images taken by cameras attached to forest machines, with the further application of image processing and analysis. There are, however, currently hardly any studies on detecting the stem damage by applying machine vision. Therefore, our study explored how the machine vision can identify tree stems and the damage in these stems.

### Material and methods

For the study, a total of 248 different size and shape injuries were made to 54 Scots pine (*Pinus sylvestris* L.) and Norway spruce (*Picea abies* (L.) Karst.) trees in later thinning stands. Each damaged tree was numbered and photographed with a Canon EOS 60D digital camera from three different directions from the strip road (Figure 1). Images were analysed with the MATLAB and ImageJ software (Figure 2).

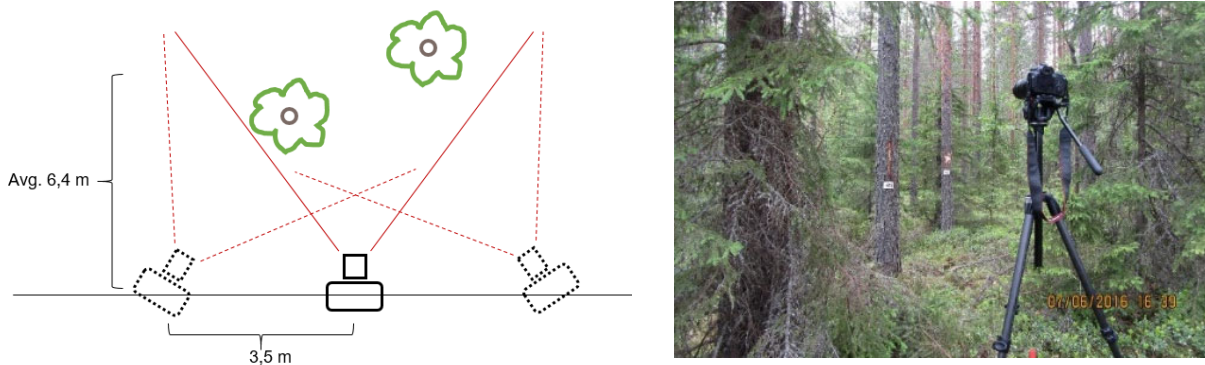

Figure 1. All trees damaged were photographed with a digital camera from the strip road at three different directions. The average photographing distance in the study was 6.4 meters.

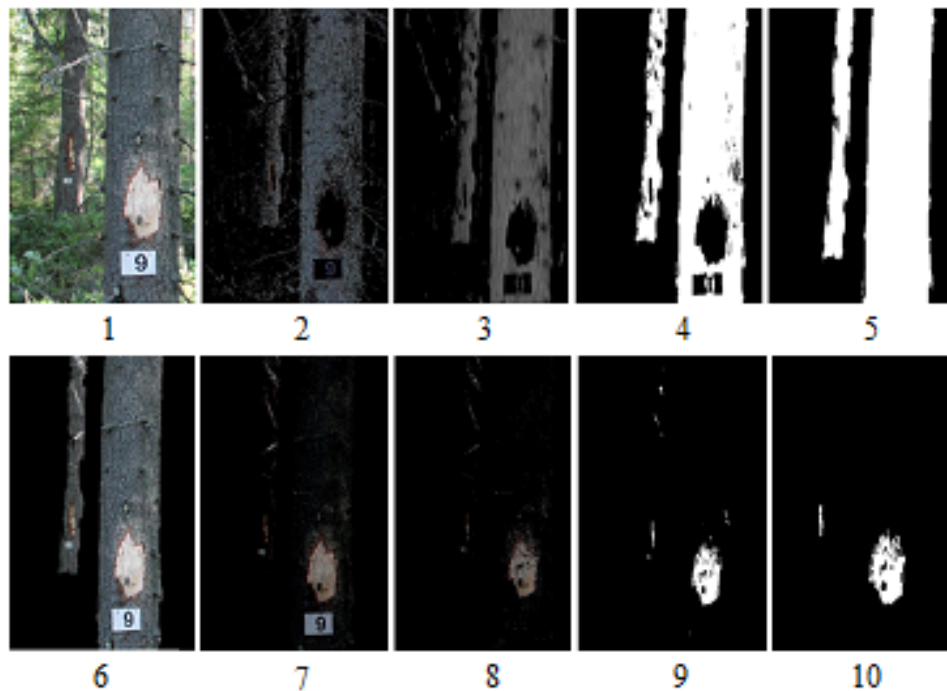

Figure 2. An example of the identification of stem damaged trees (Graph #5) and damage in the trees (Graph #10) from the original RGB photograph (Graph #1) after the image processing steps 2–4 and 6–9 were conducted.

### 3. Results and discussion

The results indicate that the stem damage could be identified best when it was perpendicularly photographed from the strip road, when the sun did not shine in the direction of photography, and when the damage was at the height of the breast diameter in the tree. Correspondingly, it was challenging to detect the stem damage when it located on the side of the stem with respect to the direction of photography, and when it was at the butt of a stem.

Moreover, when the image of the stem damage was taken against the light of the sun, it was difficult to investigate the stem damage by image processing. With the logistic regression model drawn up, we were able to identify stem damaged trees with an accuracy of 89%. By developing a discriminant model used in the study, the detection of stem damage can be further improved in the future. In addition, more field studies of camera systems for detecting and monitoring stem damage are necessary.

#### For more information

- Palander, T., Eronen, J., Kärhä, K. & Ovaskainen, H. (2018) Development of a wood damage monitoring system for mechanized harvesting, *Annals of Forest Research*, 61:2, 243–258.
- Palander, T.S., Eronen, J.P., Peltoniemi, N.P., Aarnio, A.I., Kärhä, K. & Ovaskainen, H.K. (2019) Improving a stem-damage monitoring system for a single-grip harvester using a logistic regression model in image processing, *Biosystems Engineering*, 180, 36–49.

## 4.4 Using RGB images and machine learning to detect and classify Root and Butt-Rot (RBR) in stumps of Norway spruce

Ahmad Ostovar<sup>1,2</sup>, Bruce Talbot<sup>1</sup>, Stefano Puliti<sup>1</sup>, Rasmus Astrup<sup>1</sup>, Ola Ringdahl<sup>2\*</sup>

<sup>1</sup>Division of Forestry and Forest Resources, Norwegian Institute of Bioeconomy Research (NIBIO), P.O. Box 115, 1431 Ås, Norway, <sup>2</sup>Department of Computing Science, Umeå University, 901 87 Umeå, Sweden

\*Corresponding author: [ringdahl@cs.umu.se](mailto:ringdahl@cs.umu.se)

**Keyword:** Computer vision, deep learning, timber harvesting, quality

### Abstract

Root and butt-rot (RBR) has a significant impact on both the material and economic outcome of timber harvesting. An accurate recording of the presence of RBR during timber harvesting would enable a mapping of the location and extent of the problem, providing a basis for evaluating spread in a climate anticipated to enhance pathogenic growth in the future. Therefore, a system to automatically identify and detect the presence of RBR would constitute an important contribution in addressing the problem without increasing workload complexity for the machine operator. In this study we developed and evaluated an approach based on RGB images to automatically detect tree-stumps and classify them as to the absence or presence of rot. Furthermore, since knowledge of the extent of RBR is valuable in categorizing logs, we also classify stumps to three classes of infestation; rot = 0%, 0% < rot < 50% and rot ≥50%. We used deep learning approaches and conventional machine learning algorithms for detection and classification tasks. The results showed that tree-stumps were detected with precision rate of 95% and recall of 80%. Stumps without and with root and butt-rot were correctly classified with accuracy of 83.5% and 77.5%. Classifying rot into three classes resulted in 79.4%, 72.4% and 74.1% accuracy respectively. With some modifications, the algorithm developed could be used either during the harvesting operation to detect RBR regions on the tree-stumps or as a RBR detector for post-harvest assessment of tree-stumps and logs.

### Acknowledgements

This research was funded by the Research Council of Norway, through the PRECISION project - Precision forestry for improved resource use and reduced wood decay in Norwegian Forests (project number NFR281140). The authors wish to acknowledge the support of stud.silv. Anders Askerud Ringstad for the collection of stump images, and dept. engineer Tyrone Nowell for assistance with developing and testing camera mountings and housings, as well as to several anonymous forest owners for making their harvesting sites available.

### For more information

Ostovar A, Talbot B, Puliti S, Astrup R, Ringdahl O. Detection and Classification of Root and Butt-Rot (RBR) in Stumps of Norway Spruce Using RGB Images and Machine Learning. *Sensors*. 2019; 19(7):1579.  
<https://doi.org/10.3390/s19071579>



## 4.5 ALS-based estimation of vegetation hindering cut-to-length harvesting operations

*Blanca Sanz<sup>1</sup>, Jukka Malinen\*<sup>1</sup>, Teppo Hujala<sup>1</sup>, Timo Tokola<sup>1</sup>*

<sup>1</sup>University of Eastern Finland, School of Forest Sciences

*\*Corresponding author: [jukka.malinen1@uef.fi](mailto:jukka.malinen1@uef.fi)*

**Keyword:** remote sensing, cleaning, harvesting

### Abstract

In cut-to-length harvesting, pre-harvest clearing or non-conventional approaches are needed when the forest stand has many undergrowth stems preventing the visibility to the harvested stems. Pre-harvest clearing eases the harvester operators' work, increasing the productivity and quality of the operation. Non-conventional approaches include boom corridor thinning, where harvested stems are selected based on geometrical harvesting regime instead of quality. The use of electronical marketplaces introduced require more accurate information on the properties of the tree stock and productivity of harvesting operations in the stand without actual visit.

In the study, methodologies for estimating hindering understory vegetation were developed. The field data included 97 field plots, where stems under 7 cm were measured. Moreover, all the plots were photographed, and the photos were used in an e-questionnaire that was answered by 66 forest professionals, mainly harvester operators. The respondents were asked to classify the sample plots according to amount of hindering vegetation to the five categories, which were: no need for pre-harvest clearing; pre-harvest clearing would help harvesting; pre-harvest clearing recommended; a great need for pre-harvest clearing; and pre-harvest clearing essential in order to conduct cut-to-length harvesting operation. Multispectral ALS data were collected by the Optech Titan sensor.

The results showed high variability in the classification of the need for pre-harvest clearing by forest professionals. The ALS-based recognition of the need for pre-harvest clearing proved to be challenging in the cases where the need for pre-harvest clearing was subjective, but the lowest and highest needs could be detected in most of the cases.

## 4.6 Remote sensing-based forest road trafficability modelling

Tuomo Puumalainen<sup>\*1</sup>, Jussi Peuhkurinen<sup>1</sup>, Vesa Leppänen<sup>1</sup>

<sup>1</sup>Arbonaut Ltd.

*\*Corresponding author: [tuomo.puumalainen@arbonaut.com](mailto:tuomo.puumalainen@arbonaut.com)*

### Keyword:

### Background

Arbonaut has been working on different point cloud based hydrological analysis for over ten years. The methods developed have been in active use by the forestry sector in multiple end use scenarios. Arbonaut and Metsäteho Oy have an ongoing project that started in early 2018 with a goal to build a trafficability model for seasonal risks of the private forest roads in Finland.

### Material and Methods

The Arbonaut/Metsäteho road trafficability project has currently 4 different test sites in Finland which contain total about 1000 kilometres of private forest roads. Various kinds of lidar-based data have been produced for the test sites to detect the different components that affect the seasonal trafficability. First set of field verification data have been collected during the autumn of 2018 and the measurements will continue during 2019 frost heave season. The measurements include information about the road profile and ditches, weight drop measurements and also subjective evaluations of the road overall conditions. The first version of static risk classification model has been built and will be updated further based on the additional measurement data. Machine learning methods have been the most promising alternatives for estimating risk classification so far.

Classification model is trained with field sample data and it uses lidar and publicly available GIS data as explanatory variables.

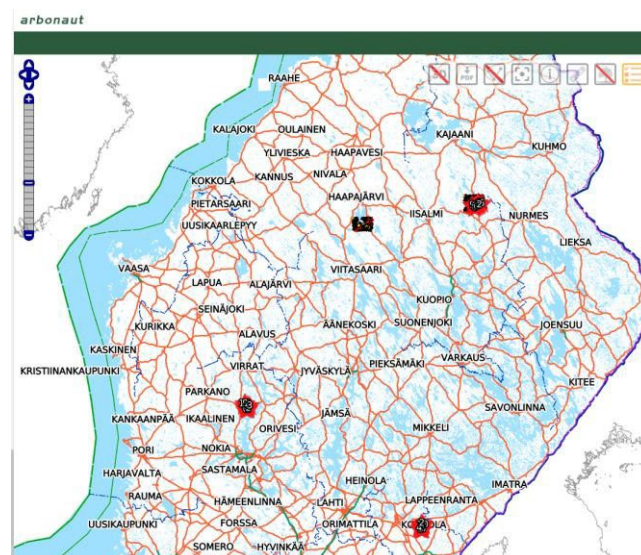

Figure 1. Test sites in Finland.

## Results and discussion

Based on the first results, the detected properties of the road profile are accurate. Additionally, the ditch conditions measured on sparse LiDAR data are very consistent with field validation data.

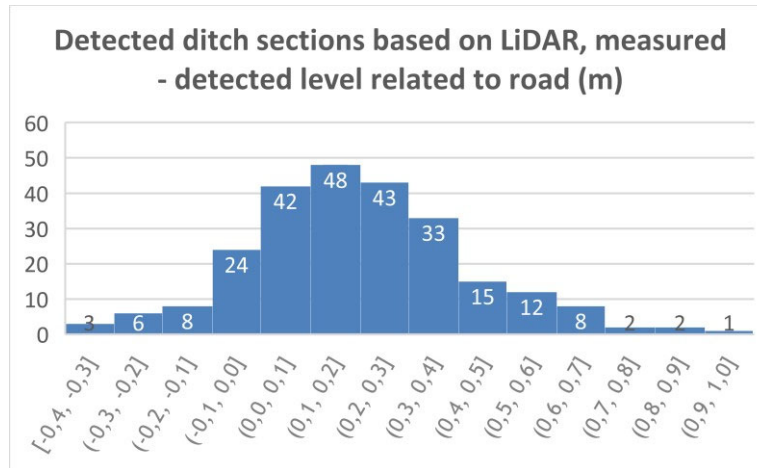

Figure 2. Detected ditches in one of the test areas.

Machine learning model trained with 504 field sample plots collected from one of the test sites achieved overall classification accuracy of 63.3% when the risk was classified in four classes and validated with leave-one-out cross-validation. The used explanatory variables were road width and ditch depth estimated from lidar data, solar radiation based on lidar derived surface model, wetness index based on lidar derived digital terrain model and soil class from open access national soil type map.

Table 1. Confusion matrix of estimated and measured road risk class. Estimated road risk class in columns and measured in rows. Road risk class 1 indicates low risk and road risk class 4 high risk

Road risk class	1	2	3	4
1	33	26	13	3
2	14	199	30	14
3	7	40	60	9
4	2	19	8	27

In the future, more measurement data needs to be collected in order to generalize the trafficability model and analyse the explanatory variables further.

## 4.7 Automatic generation of shallow ditch network in forest using LiDAR data and multispectral satellite imagery

Raitis Melniks<sup>\*1</sup>, Janis Ivanovs<sup>1</sup>, Andis Lazdins<sup>1</sup>

<sup>1</sup>Latvian State Forest Research institute “Silava”

*\*Corresponding author: raitis.melniks@silava.lv*

### **Keyword:**

### **Abstract**

Aim of this study is to develop methods for automatic surface drainage system generation using LiDAR (*Light detecting and ranging*) data and Sentinel-2 multispectral satellite imagery. LiDAR data is used for mapping of depressions in DEM (*digital elevation model*), for generation of surface water runoff and CHM (*canopy height model*) raster maps. Multispectral satellite imagery is used for detecting and separating coniferous forest stands, deciduous forest stands and other land cover types. Study area is more than 150 km<sup>2</sup> large and consists of areas on various quaternary sediment types. Three factor cost surface which includes previously mentioned data layers has been made and it is used to calculate least cost surface raster. Least cost surface connects DEM depressions and already existing drainage ditches. Least cost paths then represents best areas for shallow ditch network creation. Different methods then are applied to determine segments where it is suitable to create shallow ditches to improve water runoff. Resulting method produces acceptable results on different relief conditions with incomplete ditch network. In conditions when existing ditches and culverts are fully mapped, methods shows good results.

## 4.8 What Global Forest Watch data can tell us about timber harvesting practices - a Norwegian case study

*Fernando Rossi<sup>1</sup>, Johannes Breidenbach<sup>+1</sup>, Stefano Puliti<sup>1</sup>, Rasmus Astrup<sup>\*1</sup>, Bruce Talbot<sup>1</sup>*

<sup>1</sup> Norwegian Institute for Bioeconomy Research, NIBIO

<sup>\*</sup> *Presenter*

<sup>+</sup>*Corresponding author: johannes.breidenbach@nibio.no*

**Keyword:** remote sensing, logging, land-use, steep slope

### Introduction

Mountain catchments play an increasingly important role in the provision of ecosystems services, of which supporting functions such as physical protection against avalanches (McClung, 2017), rock-falls and land-and debris slides (Metternicht et al., 2005) are perhaps some of the most obvious. Regulation of water flow during spring thaw (Grünwald et al., 2010) and extreme precipitation events (Dyrrdal et al., 2018), as well as the supply of clean drinking water make up some of the better known provisional services (Lindner et al., 2014). Cultural services are also prevalent in mountain catchments, manifested through hiking, mountain biking, fishing and hunting (Gundersen & Frivold, 2008; Laband, 2013) as well as in the provision of timber and wood products (Schröter et al., 2014). The continued support or enhancement of these services from mountain catchments in an era of climate change, and perceived developments in size, location and extent of timber harvesting operations, requires an adaptive management approach (Heinimann, 2010). At the same time, adaptive forest management is dependent on good information on the status and the transitional processes affecting them, either through predictive models or through an analysis of empirical data. Global Forest Watch (GFW) provides an annual map of global forest cover loss (FCL) produced from Landsat imagery, and potentially offers a useful tool for environmental monitoring. In managed forests, this mostly represents commercial harvesting or windfall.

### Materials & Methods

In this study, the accuracy of the FCL map in detecting and characterising harvested sites in a 1607 km<sup>2</sup> mountainous boreal forest catchment in south-central Norway was assessed against orthophotos annually over a 17 year period. An enhanced forest cover loss map (FCLE) was produced by removing small isolated forest cover loss patches that had a high probability of representing commission errors.

### Results

While errors of commission were negligible, especially remaining seed trees and forest road construction caused errors of omission. The systematic analysis of harvested sites on orthophotos showed a detection rate of 94%, while the individual harvested site area was underestimated on average by 29%. While the accuracy improved slightly over time, site attributes considered such as slope, area, altitude, and harvested site shape - had no evident effect on the accuracy of the area estimate. The post-stratified annual harvest estimate was 0.5% (standard error 17%) of the productive forest area. FCLE was used to analyse evidence of harvesting activity annually over a 17-year period. Results showed that on average, 96% of the harvest was carried out on flat to moderately steep terrain (<40% slope), 3% on steep terrain (40% to 60% slope) and 1% on very steep terrain (>60% slope). The mean area of harvested site within each slope category was 1.7 ha, 0.9 ha, and 0.5 ha, respectively. The mean FCLE area increased from 1.0 ha to 3.2 ha on flat to moderate terrain over the studied period, while the frequency of harvesting increased from 249 to 495 sites per year. On the steep terrain, 35% of the harvesting was done with cable yarding, and 62% with harvester-forwarder systems. On

the very steep terrain (>60% slope), 88% of the area was harvested using cable yarding technology while harvesters and forwarders were used on 12% of the area. Overall, FCL proved to be a useful dataset for the purpose of detecting harvesting activity under the given conditions.

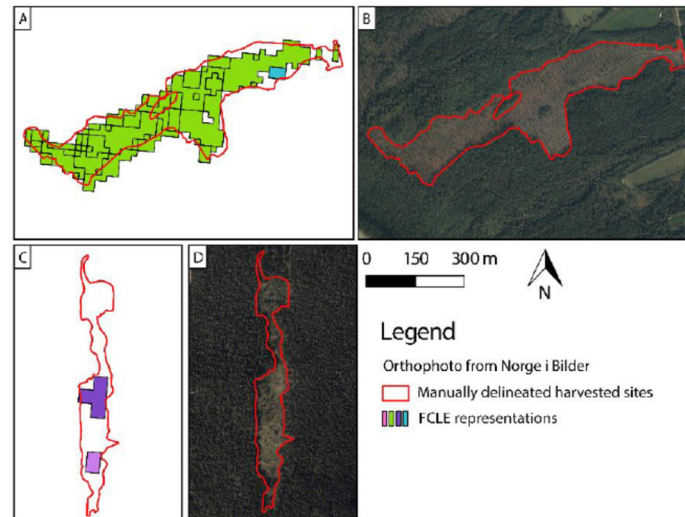

Figure 1 Examples of different success rates in site representation; GFW data (A) and the site (B) an almost perfect fit, while the GFW data in (C) only poorly represents the site (D).

## Acknowledgments

The authors wish to acknowledge the funding received from the Research Council of Norway through the REDCLIM (Reducing climate impacts on society through appropriate forestry measures)

## For more information

Rossi, F., Breidenbach, J., Puliti, S., Astrup, R., & Talbot, B. (2019). Assessing Harvested Sites in a Forested Boreal Mountain Catchment through Global Forest Watch. *Remote Sensing*, 11(5), 543.



## 5 Productivity and Efficiency





## 5.1 Impact of sorting grip and tilting grip on productivity of forwarding of logs in commercial thinning

Lazdiņš Andis<sup>1\*</sup>, Zimelis Agris<sup>1</sup>, Kalēja Santa<sup>1</sup>, Saule Guntis<sup>1</sup>

<sup>1</sup>Latvian State Forest Research Institute “Silava”

\*Corresponding author: [andis.lazdins@silava.lv](mailto:andis.lazdins@silava.lv)

### Keyword:

### Abstract

The aim of the study was to compare the tilting grip and sorting grip with a conventional grip in roundwood forwarding from commercial thinning to determine potential impact on productivity and mechanical damages of remaining trees.

The trial with the tilting grip was conducted in four coniferous stands in Ziemeļkurzeme region, Rinda forest compartment, Ance surrounding, in forest area under the governance of Joint Stock Company “Latvia State Forests” (LSF). Two working methods were compared. In the first method forwarder is equipped with tilting grip and in the second method – a standard grip was used. Both methods were applied in the same stands with John Deere 810 D forwarder. Forwarding was carried out by two operators with similar working experience with both the tilting grip and the standard grip. During the trials time studies were done and damages of remaining trees by forwarder and harvester were accounted. The trials with sorting grip were conducted in 3 coniferous stands (total area – 15,2 ha) in forests on drained mineral soils under the governance of LSF, located in Northern Kurzeme region, Raķupe forest compartment, Anūži surrounding. In the trials 2 working methods were compared – forwarding with John Deere 1110D ECO III forwarder equipped either, with sorting grip or conventional grip.

According to the study results use of tilting grip increase forwarding productivity by 21%. Impact of operators on average productivity was not statistically significant. Use of tilting grip in typical work conditions in commercial thinning significantly reduces forwarding cost. In the study sites average forwarding cost in case of tilting grip was 5.9 € m<sup>-3</sup> and in case of conventional grip – 7.4 € m<sup>-3</sup>. The amount of damages on remaining trees reduced by 21% in areas, where the tilting grip was used. The average share of damaged trees during trials was comparatively small.

According to the sorting grip study results use of standard grip instead of sorting grip slightly increases productivity – by 1.4% of productive work time per 1 m<sup>3</sup>. Although difference in the productivity indicators is not significant, trials should be continued in conditions with higher number of assortments to transport. It would allow to evaluate advantages of the sorting grip. In the study conditions forwarding costs using standard grip were 9.4 € m<sup>3</sup>, but while using sorting grip – 9.5 € m<sup>3</sup>. The use of sorting grip reduces share of damages on remaining trees insignificantly, by 0.1%.

## 5.2 Impact of feed rollers on productivity, log damages and fuel consumption during harvesting

Polmanis Kaspars<sup>1\*</sup>, Zimelis Agris<sup>1</sup>, Spalva Gints<sup>1</sup>

<sup>1</sup>Latvian State Forest Research Institute “Silava”

\*Corresponding author: [kaspars.polmanis@silava.lv](mailto:kaspars.polmanis@silava.lv)

### **Keyword:**

### **Abstract**

The aim of the study is to compare the standard side feed rollers of the harvester head with the *Moipu Flex Standard* side feed rollers (Moipu), by evaluation of the depth of the imprints depending on the type of felling, tree species and type of assortment. During the study data were obtained from commercial thinning using John Deere 1070E harvester and from regenerative felling using John Deere 1270E harvester. Measurements of imprints were done for the following assortments – birch veneer logs (FIB), as well as for pine and spruce logs (top diameter 10x14 cm, 14x18 cm and 6x10 cm). The selection of the test objects was carried out using the list of felling areas sent by JSC “Latvijas valsts meži”, broken down by months, in which logging was planned.

According to the study results Moipu feed rollers significantly reduces depth of imprints, but the additional pressure caused by the central feed roller significantly worsens the quality of the assortments produced by Moipu feed rollers by increase of the depth of the imprints. The positive effect of Moipu feed rollers is also diminished by the feed roller splines, which increase the depth of wood damage. This type of damages can be significantly reduced by proper regulations of pressure in felling head. Use of the Moipu feed rollers also reduces debarked area of logs thus potentially increasing storage time of logs in summer; however, this impact is not evaluated further during the study. The positive impact of Moipu feed rollers express more significantly during production of small diameter logs.

## 5.3 Long-term follow-up study on fuel consumption of harvesters and forwarders in wood harvesting in Finland – Preliminary results

*Hanna Haavikko<sup>1\*</sup>, Kalle Kärhä<sup>2</sup>, Heikki Kääriäinen<sup>1,2</sup>, Teijo Palander<sup>1</sup>*

<sup>1</sup>University of Eastern Finland, <sup>2</sup>Stora Enso Wood Supply Finland

*\*Corresponding author: hanna.haavikko@gmail.com*

**Keyword:** energy efficiency, cutting, forest haulage, logging, industrial roundwood.

### Abstract

Comprehensive follow-up studies on the fuel consumption of logging machines (i.e. harvesters and forwarders) have not been conducted during the last fifteen years in Finland. Moreover, there are only a few global long-term follow-up studies on the fuel consumption of wood harvesting machinery. Emission calculations also call for updated information about fuel consumption in cut-to-length logging operations. Furthermore, it is essential to understand the effect of different factors (e.g. harvesting conditions and the machine operator, as well as the machine and its adjustments) on fuel consumption in cutting and forwarding. Consequently, the aim of the study was to determine and model the fuel consumption of harvesters and forwarders in cut-to-length logging operations in Nordic wood harvesting conditions in Finland. The follow-up study measuring the fuel consumption began in March 2018 and ended in April 2019. The fuel tanks of logging machines were equipped with the digital Piusi K24 flow meters, with an accuracy of  $\pm 1\%$ . There were 14 harvesters and 12 forwarders in the study. Across all study data, the average fuel consumption per hour was the highest for both harvesters and forwarders in clear cuttings (harvesters: 17.7 l/h and forwarders: 13.1 l/h). In first and later thinnings, the fuel consumption per hour was, on average, 14.7 and 14.8 l/h with study harvesters and with forwarders it was 12.8 and 12.0 l/h, respectively. Correspondingly, the fuel consumption per cubic meter harvested was significantly lower when logging industrial roundwood from clear cuttings: Total fuel consumption averaged 1.58 l/m<sup>3</sup> in clear cuttings while for later and first thinnings it was, on average, 2.51 and 3.56 l/m<sup>3</sup> respectively. In addition to the cutting method, the results revealed that the machine operator and harvesting conditions have a significant effect on the fuel consumption of forest machines. The results obtained can be used to improve the fuel efficiency in logging operations and the training of machine operators, as well as enable emission calculations to be drawn up.

## 5.4 Modeling harvester's productivity applying statistical machine learning methods to standard machine monitoring data

*Paula Jylhä<sup>1</sup>\*, Pekka Jounela<sup>1</sup>, Eero Liski<sup>1</sup>, Markku Koistinen<sup>1</sup>, Heikki Korpunen<sup>1</sup>*

<sup>1</sup>Natural Resources Institute Finland (Luke)

*\*Corresponding author: paula.jylha@luke.fi*

### **Keyword:**

### **Abstract**

Harvesters' productivity and fuel consumption were analysed applying statistical machine learning methods to standardised operational machine monitoring data complemented with additional variables. The predictors' impact on productivity were estimated using linear support vector regression (SVR) weights and the productivity patterns were recognized using gradient boosted machine models. Productivity was also predicted using linear regression. In both approaches, the models' parameters were optimized using 10-fold cross-validation. Furthermore, the structure of harvester's time consumption and harvesting conditions were analysed. The data covered in all 1 530 stands (ca. 626 000 m<sup>3</sup>) harvested in Finland in 2014–2017. Due to heterogeneity of the machine monitoring data, partial datasets were formed. The sample size was ca. 500 thinning and final felling units (ca. 500 000 m<sup>3</sup>).

The average productivity was 15.1 m<sup>3</sup>/E<sub>o</sub>-h in thinnings and 31.4 m<sup>3</sup>/E<sub>o</sub>-h in final fellings. Mean stem volumes were 131 and 349 dm<sup>3</sup>, respectively. Harvester operator explained ca. 40% of the variation in predicted productivity. When compared to the follow-up productivities published in the 1990's, the efficiency of cutting had increased more rapidly in thinnings than in final fellings. Effective processing time (E<sub>o</sub>) covered on average 70% of utilised machine hours. The results from productivity and fuel consumption indicate that large-sized harvesters were partially used outside their optimum conditions in terms of stem size. Machine learning methods showed potential for analysing data with complex interactions between predictors.

### **Acknowledgment**

The study was conducted in the FOBIA project, funded by the Northern Periphery and Arctic 2014 –2020 Programme.

## 5.5 Productivity, logging costs and wood value for harwarder in final felling

*Rikard Jonsson*<sup>1\*</sup>

<sup>1</sup>Skogforsk

*\*Corresponding author: Rikard.Jonsson@skogforsk.se*

### **Keyword:**

### **Abstract**

The harvester-forwarder system dominates the cut-to-length logging operations. The systems' productivity has however stagnated and only minor increase in productivity of cut-to-length system has been seen during the last decade. Consequently, research on new alternative systems is actual. One alternative is harwarder, a single-machine-system combining harvester and forwarder work. The harwarder's strength is the ability to directly load logs as they are cut, thereby eliminating the traditional forwarder work element loading. The past five years, Skogforsk has done several studies on the harwarder prototype Komatsu X19, showing competitiveness compared with the harvester-forwarder system in logging costs and wood value. This have been shown especially in smaller stands and with shorter driving distance. A summary of study results on Komatsu X19, ongoing studies and description of potential in further development will be presented.

## 5.6 Automation of harwarder work – evaluation of effects on performance and user experience

*Martin Englund<sup>1\*</sup>, Jussi Manner<sup>1</sup>, Rikard Jonsson<sup>1</sup>, Anders Mörk<sup>1</sup>*

<sup>1</sup>Skogforsk

*\*Corresponding author: martin.englund@skogforsk.se*

### **Keyword:**

### **Abstract**

The harwarder is a single machine system that combines the tasks of both harvester and forwarder. With a harvester head it fells the trees in the same manner as a harvester. The stem is then crosscut directly onto the harwarder's load space. When full, the harwarder will do the job of the forwarder by extracting the logs to roadside. For unloading, the head is replaced by a grapple.

The fact that the place for crosscutting is the same for every stem means that the work is more predictable, which is an advantage in development of automation.

For this study, automation have been developed to assist the operator in four tasks in the process from felling to crosscutting. Both development and evaluation have been done in a real time machine simulator. The simulated environment gives the opportunity to perform studies of the effects of the automation by offering controlled and repeatable conditions.

Professional operators with experience from harwarder work are used for the evaluation where the automated harwarder is compared to manual operation of the same machine. Results from a time study and interviews with the operators will be presented.

## 5.7 Silvismart, an EU-wide Efficiency Portal for forest operations

*Simon Berg*<sup>\*1</sup>, *Bruce Talbot*<sup>1</sup>, *Rasmus Astrup*<sup>1</sup>

<sup>1</sup>Norwegian Institute for Bioeconomy Research

*\*Corresponding author: [simon.berg@nibio.no](mailto:simon.berg@nibio.no)*

### **Keyword:**

### **Background**

One of the aims of the EU Horizon 2020 Tech4Effect project is to contribute to improving the efficiency of forest operations and therewith the profitability of the the sector. This is attempted in part by providing a benchmarking tool for forest contractors. However, before benchmarking is possible, a robust system recording and providing different stakeholders with access to basic data from forest machines is necessary. This is the reason that a group of apps collectively called Silvismart have been developed. Silvismart currently consists of 4 apps, while more are being developed. Two apps for contractors that show data based on machines (My Fleet) and on site (My Operation). One app for forest owners (My Forest) that shows data for the harvested stands (e.g. species, volumes, assortments), and one app for administration (My Files), where the contractors can recover their raw files or provide access for others. The Silvismart system and all the apps are designed to make data available to different actors within the GDPR framework.

### **Material and Methods**

The applications have been developed in Shiny, which is an R library for developing web applications. The data from participating machines have been automatically transferred and read in to a database hosted on SQL servers from which the apps also makes calls for data. The files that are received include different types of StanForD files. Both StanForD classic and 2010 is supported, where classic is converted to 2010 during parsing in order to allow for the data to be combined in the same database.

### **Current status**

There are currently 65 machines from eight different countries that are or have been sending in data to the Silvismart database. The apps are still under development as more and more features are added to the apps at the same time more apps are developed. The My Fleet presents productivity data (Figure 1) from the perspective of the machine owner. The My Operation app presents productivity data (Figure 1) and GIS (Figure 2) data based on stand so that all machines that have been working in one stand have a combined dataset. The My Forest app presents some data concerning harvested volumes and assortments, as well as GIS data for the stand or stands. However, no machine or operator information is presented to the forest owner – which is a significant step in ensuring only appropriate data is shared. The My Files app makes it possible for the contractors to grant forest owners access to data about the forest.

### **The journey**

The process of improving these applications is ongoing but a lot has been learned about the challenges of working with big databases and variations in data standards and quality. A particular challenge is to handle large databases and reasonably quickly send queries and get data from the database. The main problem is that data tables quickly become very large, so it is only possible to make calls for limited amount of data. This can be solved by having a limited table only containing the information needed to make calls to the server.

The data is also sensitive to errors or omissions in manually entered information. For example differences in capitalization, abbreviations, and simply differently entered naming data such as site and operator identification lead to challenges in providing watertight solutions where data fidelity can be guaranteed. There can also be other irregularities in the data that make it difficult to use, making strict filtering routines



necessary. This is an important area to continue monitoring as irregularities can be both due to error in the parsing of the sent files or caused by data error on the machines or by user settings. An important first step is to develop documentation and feedback for the machine owners on what information needs to be included in the the StanForD files for it to be beneficial in to them in the reporting.

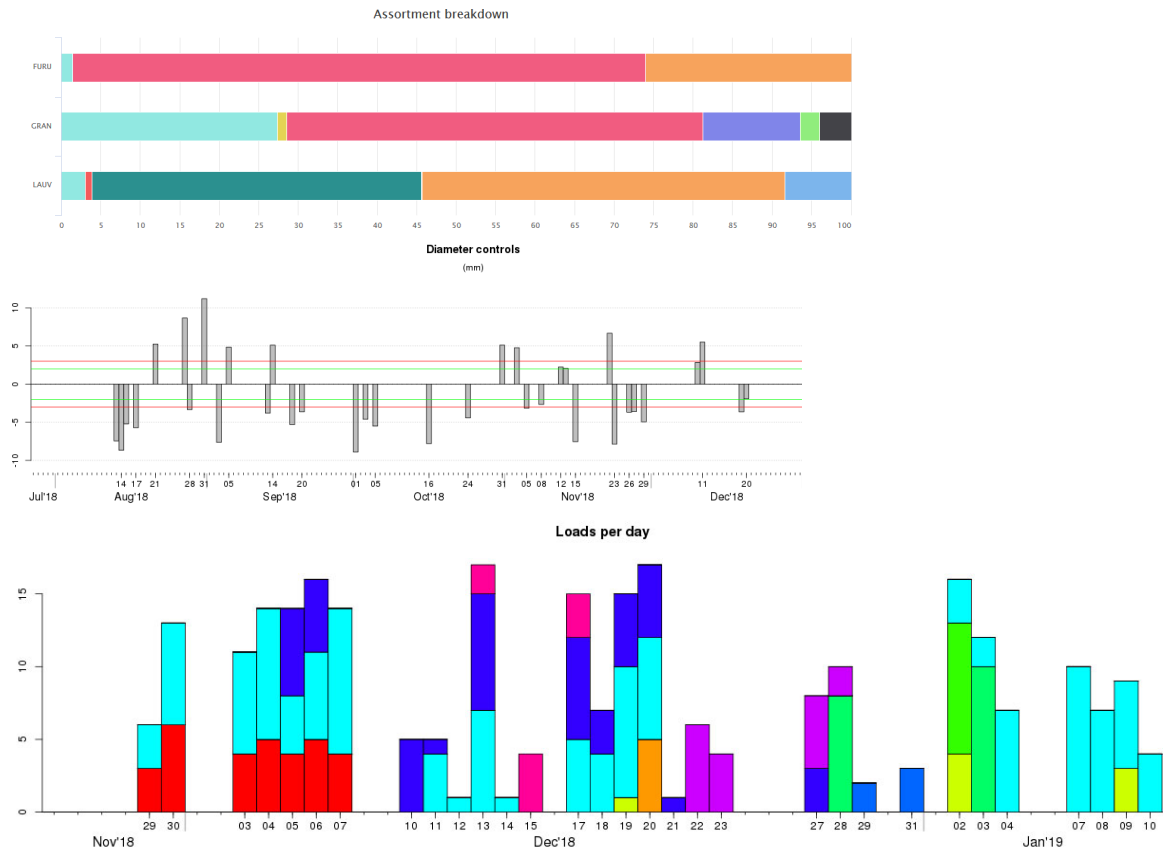

Figure 1. Assortment breakdown at a site or for a machine (top); control measurements at a site or for a machine (middle); forwarder productivity at a site or per machine (bottom).

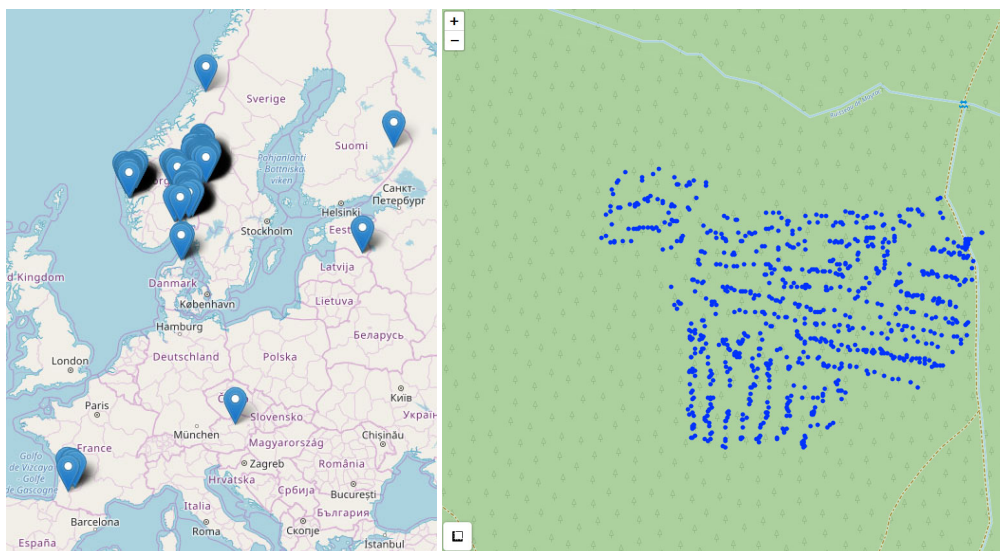

Figure 2. Map over different stands in My Operation (left), a map over a stand showing the positions where the harvester was located at the time of felling (right).

## Acknowledgment

The H2020 Bio-Based Industries supported project, TECH4EFFECT (Grant Agreement No. 720757). Further information is available at [www.tech4effect.eu](http://www.tech4effect.eu)

## 5.8 Uncovering the technical performance potential of CTL harvesters

Rolf Björheden<sup>\*1</sup>

<sup>1</sup>Skogforsk

*\*Corresponding author: rolf.bjorheden@skogforsk.se*

**Keyword:** CTL Harvester, Performance, Fuel consumption, Value recovery, Ergonomics, Noise, Vibrations, Operator support, Automation

### Abstract

Five large CTL harvesters, John Deere 1470G, Komatsu 951, Logset 12H, Ponsse Bear and Rottne H21, were studied to investigate how extreme performance rates would affect fuel consumption, exposure to whole body vibrations, noise levels, work quality and wood value recovery. The study was carried out under fair summer conditions, in a mature Scots pine stand with an average tree size of 0,65 m<sup>3</sup>sub.

The drivers' tactical choices and mode of operation is a decisive factor for fuel economy and performance and affects vibration patterns and the prerequisites for high value recovery, such as stem grasp. Each machine-operator combination should be considered an entity or *team*.

All machines were driven by one or two ordinary operators. In total seven teams were studied, each for approximately three hours productive time ( $E_o$ ). Vibration levels were recorded, and the operation was registered by a GoPro camera for subsequent evaluation of work. Noise levels were recorded separately, after the work study.

All operators were skilled. They reached performances between 160 – 210 per cent of the norm during the limited study time, providing evidence of the high technical production potential of current harvesters. An important factor currently limiting harvester productivity is that a normal operator cannot produce at the rate technically possible for any length of time.

All harvesters offered good working environment with respect to vibrations and noise levels, also during intense harvesting of large-sized trees. Bucking, stem grasp, piling and sorting were graded from 'acceptable' to 'good' for all studied teams.

The cab was generally roomy, although stow-away for clothes etc may be improved. The accessibility was acceptable although the height to the first step and placement of hand-rails commonly led to penalty points.

The essential conclusion is that systems that simplify machine operation and reduce mental workload of the operator, e.g. through partial automation, would allow operators to increase their performance without improving the harvesters' basic technical properties. This observation is an important guiding statement for continued technical development.



## 6 Forest Regeneration and Small Tree handling



## 6.1 Site preparation: history, present situation and the future.

Lars-Göran Sundblad\*<sup>1</sup>

<sup>1</sup>Skogforsk, Sweden

\*Corresponding author: [lars-goran.sundblad@skogforsk.se](mailto:lars-goran.sundblad@skogforsk.se)

### **Keyword:**

### **Abstract**

The talk will give a short historic summary of the development of site preparation, describe its current status and discuss development for the future. Three aspects will be covered; biology, technology and sustainability.

- Biology will be discussed in terms of the biological target for site preparation. How it has changed over the years and what the future target might be. The theoretical basis for different targets will be discussed based on the idea that biology defines what we want to achieve by site preparation and why.
- Historic, present and potential future technology will be discussed in terms of how we have tried, how we are trying and how we in the future might try to meet varying biological targets. It will focus on what types of machinery we have used, are using and possible will be using in the future. Development of site preparation designed for potential future mechanized planting will be discussed separately.
- Environmental aspects of site preparation will be discussed in a sustainability context. Three aspects of sustainability will be covered: Economic-, ecological- and social sustainability.

The overall aim of the talk will be to discuss what we can learn from experiences and scientific results up to now and how we can combine such historical knowledge with new biologic findings, new technologies and an increased understanding of the importance of implementing sustainability aspects in a development process for the future.

## 6.2 Improved forest regeneration operations in Latvia – transfer and adaption of Nordic technologies -mechanized planting

Dagnija Lazdina<sup>\*1</sup>, Karlis Dumins<sup>1,2</sup>, Toms Arturs Stals<sup>1</sup>, Kristaps Makovskis<sup>1</sup>,  
Timo Saksas<sup>3</sup>

<sup>1</sup>Latvian State Forest Research Institute “Silava”, Latvia, <sup>2</sup>Latvia University of Life Sciences and Technologies, Latvia, <sup>3</sup>Natural Resources Institute Finland, Finland

\*Corresponding author: [dagnija.lazdina@silava.lv](mailto:dagnija.lazdina@silava.lv)

### Keyword:

### Abstract

Soil preparation method mounding is a solution for water regime in areas with unfavourable water regimes. In the last decades, extreme weather conditions occur more often. The lack and ageing of labour involved in basic forest management work and the cost of labour are going up, therefore we have preconditions for involving mechanized planting on mounds in forest regeneration practice in Latvia. The aim of study is to compare cost, quality and productivity of mechanized planting and manual planting in Latvian conditions if 2-2.5 thousands trees are planted per hectare. Planting machine M-planter and mounding device MPV 600 were used for forest regeneration operations. Average productivity of mechanized planting per 1 ha was 11.9 h, but making of mounds by MPV600 and manual planting together was 11.2 h per ha in average. The cost of mechanized planting in Latvian conditions varies between 440-550 EUR depending on the number of seedlings planted and planting conditions in comparison to 520 EUR for manual planting and soil preparation separately. Survival of seedlings on mounds was similar for both methods used, it depends more on the localization in the stand than the method used for soil preparation and planting.

### Background

There are two main reasons for promotion of mechanized tree planting of which one is economical pressure to decrease silviculture costs and labour shortage as well as the increase in total costs of forest management (Ersson et al., 2018). The main reason why mechanized planting is not already widely used is the cost in comparison to manual planting. Studies in Latvia also suggest that mechanized planting as a forest management technique may be too expensive, but cost was compared with disc trenching and manual planting in furrows (Liepins et al., 2011). Previous calculations conducted in Finland suggest that mechanized planting productivity are in average 13,21 second per seedling (Line&Rantala, 2012)

### Material and Methods

As planting material Scots pine (*Pinus sylvestris*) and Norway spruce (*Picea abies*) containerized seedlings were selected, since these are two of three economically most valuable tree species in Latvia. Two trials were established on fertile mineral soil with a natural water regime (*Myrtilloso-sphagnosa*) located at 56.778349, 24.214402, two sites were on drained forest land with peat layer thicker than 35 cm (*Myrtillosa turf.mel.* & *Oxalidosa turf. mel*) located at 56.776281, 23.841026 and 56.777830, 23.852595 and the last two sites were established on drained forest land with peat layer less than 35 cm (*Myrtillosa mel.* & *Mercurialiosa mel.*). The cost model elaborated within the COST action FP0902 was chosen to evaluate prime costs of mechanized forest regeneration (Ackerman et al., 2014). It has been adapted for conditions in Latvia and previously used during the first mechanized planting trials in Latvia in 2007 and 2008 and later in 2012 when cost efficiency of soil preparation in mounds was evaluated. After first and the second growth season the height of spot mound and the depth of adjacent pit changes were measured and seedling survival counted. For mechanized plating the M-planter was chosen as it has already been previously tested in Latvia (Liepins et al., 2011) and as an alternative for mound preparation MPV 600 of similar construction was used ( Fig.1).

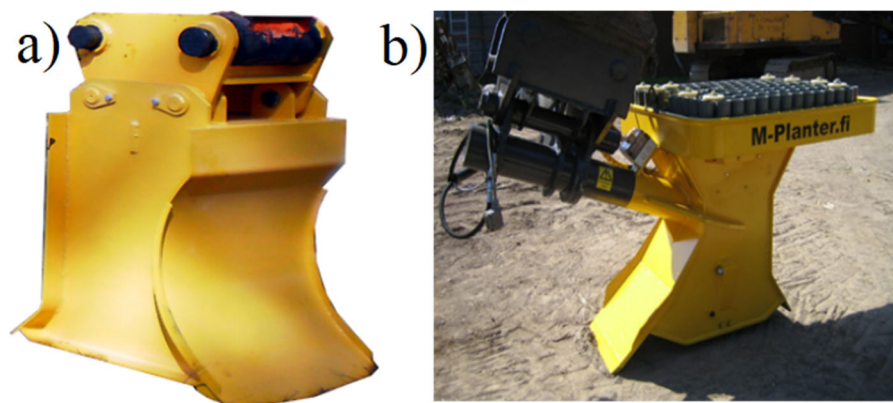

Figure 1. Devices used for soil preparation a) MPV-600. B) M-Planter.

## Results and discussion

Manual planting consisted of two phases, one of them being soil preparation with the MPV-600 bucket. On average it took 10.5 seconds to prepare a planting spot in drained peat soil, but more time was necessary on drained mineral soils – 10.7 seconds and in undrained loamy soil site – 12.4 seconds. Manual planting with a planting tube for one seedling was considered to be 9.18 seconds. Overall planting productivity with M-Planter slightly differed between forest types – in peatland (peat layer deeper than 35 cm) forest sites the average time spent for one planted seedling was 18.1 seconds, in drained mineral soil – 18.9 seconds, but in the forest site with natural water regime (*Myrtilloso-sphagnosa*) it took even 23.4 seconds to plant one seedling. In practice that means 2000 seedlings planted per hectare in 10.2-12.0 (on average 11.2) hours in average manually or from 10.2-14.1 (in average 11.9) hours by machine.

After the second growth season in all forest types for both methods except *Myrtilloso-sphagnosa* the average height of mounds decreased. Excluding undrained forest sites (*Myrtilloso-sphagnosa* forest type), the height of mounds prepared by MPV 600 reduced by 8 % to 22 % but spot mounds that were prepared by M-planter decreased by 5 % to 15 %. The depth of pit reduced in all stands and in all variants. On average depth decreased by 18 % where M-planter was used and an average reduction of 15 % where MVP 600 was used.

After the second season the overall survival rate for both methods was sufficient and two seasons after planting 85 % of mechanically planted spruce have survived compared to 87 % of manually planted. For pine the survival rate was higher for mechanically planted – 97 % and 92% for manually planted trees.

The reduction of planting density and improvement of planting productivity would decrease prime forest regeneration costs. If it could be possible to reach planting productivity that has been recorded in previous studies (210 seedlings per hour), then prime cost for one-hectare regenerations would be 447 EUR ha<sup>-1</sup>. In forest types *Myrtilloso-sphagnosa*, *Myrtillosa mel.*, *Mercurialiosa mel.*, *Myrtillosa turf.mel.*, *Oxalidos turf. mel.*, according to research, mechanized planting prime costs results varied from 440 to 550 EUR ha<sup>-1</sup> in comparison to mounding (~400 EUR) and manual planting (120 EUR), total costs being 520 EUR, mechanized planting nowadays is not a significantly more expensive method.

## References

- Ackerman, P., Belbo, H., Eliasson, L., Jong, A., Lazdins, A. & Lyons J. (2014) The COST model for calculation of forest operations costs, *International Journal of Forest Engineering*, 25:1, 75-81
- Ersson, B.T., Laine, T., Saksa, T. (2018) Mechanized tree planting in Sweden and Finland: Current state and key factors for future growth, *Forests*, 9:7, article number 370.
- Laine, T., Rantala, J. (2013) Mechanized tree planting with an excavator-mounted M-Planter planting device, *International Journal of Forest Engineering*, 24:3, 183-193.
- Liepiņš, K., Lazdiņa, D., Lazdiņš, A. (2011) Productivity and cost-effectiveness of the m-planter tree planting machine in Latvian conditions, *Baltic Forestry*, 17:2, 308-311.
- Mechanized planting has been carried out in Research program funded by Latvian State Forests. Establishment of the trials were possible thanks to the contacts obtained by the NB-NORD network and the response of LTD M-planter.*



## 6.3 State-of-the-art of mechanized tree planting and pre-commercial thinning operations in Finland

*Taru Timonen<sup>1,2</sup>, Kalle Kärhä<sup>1\*</sup>, Markku Oikari<sup>1</sup>, Markus Strandström<sup>3</sup>, Heli Peltola<sup>2</sup>, Kari Kuusniemi<sup>1</sup>, Jukka Piipponen<sup>1</sup>*

<sup>1</sup>Stora Enso Wood Supply Finland, <sup>2</sup>University of Eastern Finland, <sup>3</sup>Metsäteho Ltd

*\*Corresponding author: kalle.karha@storaenso.com*

**Keyword:** mechanization, silviculture, development, internet survey, Finland.

### Abstract

Nowadays, the use of mechanized tree planting and pre-commercial thinning is at a low level in Finland. According to statistics by the Natural Resources Institute Finland, in 2017 their areas totalled, respectively, only 3,100 and 1,300 hectares, and only 3.9% and 0.9% of the total tree planting and pre-commercial thinning areas. The aim of the study was to clarify the current most significant bottlenecks in mechanized tree planting and pre-commercial thinning operations and the possibilities for increasing their use and areas in the future. Forest machine entrepreneurs, silviculture and wood procurement managers, forest machine manufacturers, and representatives of R&D organizations participated in the study, which was carried out as an electronic Webropol internet survey in February 2018. A response link for the survey was sent to a total of 317 persons, and 104 respondents replied to the questionnaire, a response rate of 32.8%. The results of the survey revealed that the most significant bottlenecks in the increase of the use of mechanized planting are soil stoniness and the small size of worksites, the small annual planting volume per machine, low productivity, and deficient pre-information about surface stoniness and the soil type of planting sites. Correspondingly, with mechanized pre-commercial thinning, the most important factors which restrain its expansion are the low cost-competitiveness of mechanized work, the timing of mechanized work, the small annual areas per machine, low productivity, and the prejudices of forest owners. The respondents underlined that the acceleration of mechanized planting and pre-commercial thinning operations requires higher productivity and cost-competitiveness and better awareness of both types of mechanized works. Furthermore, the respondents pointed out that the selection of suitable planting worksites and the logistics of seeding deliveries must be improved in mechanized tree planting. Moreover, it was considered that the technology of machines in pre-commercial thinnings, as well as the quality and timing of mechanized pre-commercial thinning, should be improved. The findings of the study can be utilized to enhance the use of mechanized tree planting and pre-commercial thinning operations in Finland and further to intensify mechanized work areas.

## 6.4 Simulating concepts for fully mechanized stand regeneration

Jussi Manner<sup>1+</sup>, Isabelle Bergkvist<sup>1</sup>, Gert Andersson<sup>\*1</sup>, Petrus Jönsson<sup>1</sup>,  
Lars-Göran Sundblad<sup>1</sup>, Back Tomas Ersson<sup>2</sup>

<sup>1</sup>Skogforsk, <sup>2</sup>Skogsmästarskolan, Swedish University of Agricultural Sciences (SLU)

\* *Presenter*

+ *Corresponding author: jussi.manner@skogforsk.se*

### Keyword:

### Abstract

Boom-tip mounted planting devices are currently the only fully mechanized systems available commercially for reforestation in the Nordic countries. These devices prepare the soil (generally via spot mounding) and plant a seedling, both during the same work cycle. Bracke p11 and M-planter are the most common devices on the market. When mounted on excavators, these systems provide excellent silvicultural results, but their productivity is poor. Consequently, today's tree planting machines generally cannot compete economically with today's most common regeneration system, i.e. mechanized scarification followed by manual planting.

The objective of the present study was to investigate novel conceptual systems for fully mechanized stand regeneration that could possibly compete with mechanized scarification and manual planting. We created four alternative systems using discrete-event simulation. The systems were as follows:

- 1) Mechanized scarification (disc trenching, continuously advancing) and manual planting.
- 2) M-planter or Bracke p11, i.e. mounding with planting (fully mechanized, intermittently advancing).
- 3) SilvaNova 2.0 (fully mechanized, continuously advancing).
- 4) SilvaSuperNova (fully mechanized, continuously advancing).

Hence, systems 1 and 2 already exist, whereas systems 3 and 4 are purely conceptual. SilvaNova 2.0 and SilvaSuperNova are upgraded versions of the old Silva Nova planting machine (which was large, expensive and mounted on a forwarder's load-space). The original Silva Nova was operated by two operators, one drove the base machine while the other operated the planting unit. Moreover, later versions of the Silva Nova were equipped with MIDAS trenching units (which were mounted in front of the rear bogie so that it immediately compacted the berm, effectively inverting the soil and humus). To improve competitiveness, we assumed the SilvaNova 2.0 planting unit to be fully automated and the whole machine to be operated by a single person. Meanwhile, the SilvaSuperNova is assumed to be completely autonomous, it follows a beforehand programmed path.

The simulation results confirmed current knowledge: mechanized scarification can efficiently create many planting spots per hectare making *System 1* the most cost-efficient, non-autonomous alternative. Meanwhile, mounding with planting (*System 2*) was the most expensive alternative. SilvaNova 2.0 was slightly more expensive than *System 1*, but cheaper than *System 2*. And finally, the autonomous SilvaSuperNova was slightly cheaper than *System 1*. Thus, the simulations showed that SilvaNova 2.0 and SilvaSuperNova (*Systems 3* and *4*) probably have some development potential. But equally important, the simulation showed that the silvicultural results (in terms of occurrence of empty areas lacking seedlings) are a relative weakness of *Systems 3* and *4*.

## 6.5 Flowcut: A felling head for continuous felling and accumulation, the second evaluation

Örjan Grönlund<sup>1</sup>, Henrik von Hofsten<sup>1</sup>, Maria Iwarsson Wide<sup>\*1</sup>

<sup>1</sup>Forestry Research Institute of Sweden, Uppsala Science Park 751 83 Uppsala, Sweden

*\*Corresponding author: maria.iwarssonwide@skogforsk.se*

**Keyword:** early thinning, time studies, felling head, bioenergy

### Abstract

In many countries there has been a steadily increasing interest in forest bioenergy during the last decade. There are many sources and types of removal of forest bioenergy, both within dense stands, along road-sides and power-lines as well as different kinds of overgrowing land.

The felling head Flowcut can perform continuous cutting and accumulation of small diameter trees. This principle for cutting enables a drastically increased performance in early, biomass dense, thinning's. Results from a test of the first prototype were promising and showed that the technological principle could increase profitability in early thinning's. The tests also indicated aspects that require further development. In a new study the second prototype is about to be studied and the new tests will be presented at the NB-Nord conference.

The first test has shown a great potential for the principle of performing continuous cutting and accumulation of small diameter trees in dense stands. The new test will be small scale and using a new prototype after some remarks in earlier tests as to how the concept could be improved. In the first tests the abundance of damaged but not harvested trees were acceptable but still leaves room for improvement. The second point for improvement is the accumulation. The arms designed to grip and hold the trees did at times fail to perform this task resulting in dropped trees. Given these remarks the prototype now has been updated and a working method has been developed. Studies will take place during week 13. This technology may be the most efficient choice in many situations.

## 6.6 Why are undergrowth trees still pre-cleared before first thinning operations?

*Bergström D.\*<sup>1</sup>, Ersson B.T.<sup>2</sup>*

<sup>1</sup>Swedish University of Agricultural Sciences (SLU), Department of Forest Biomaterials and Technology, 901 83 Umeå, Sweden, <sup>2</sup>Swedish University of Agricultural Sciences (SLU), School of Forest Management, 739 21 Skinnskatteberg, Sweden

*\*Corresponding author: dan.bergstrom@slu.se*

### **Keyword:**

### **Abstract**

Pre-clearing undergrowth trees is intended to increase the operational efficiency during first thinning. Currently, the main problem with undergrowth is the occurrence of sight-hindering trees (generally small spruce trees) which makes positioning the harvester head time consuming. Larger undergrowth trees may also increase time consumption when repositioning the head, because the head's travelling distance may increase when the shortest distance between harvested trees is hindered. Hence, pre-clearing is justified by the forest industry because it facilitates reduced costs during the cutting work. However, pre-clearing is also very costly, and several studies indicate that pre-clearance often results in higher total thinning cost. Besides, with today's technology, it is possible to support operator vision and to clear-away (or cut and accumulate) those trees that block the harvester head from travelling the shortest possible path between harvested trees.

The objective of our study is to assess (using knowledge from several recent studies) the effect of undergrowth trees on the harvester's thinning efficiency and cost, and, using up-to-date pre-clearance costs, analyze the systems' total costs. Using current literature, we also aim to assess those technologies and methods that might eliminate the need for pre-clearance, while still maintaining high operational cost-efficiency during first-thinning cutting work. Our goal is to present possible solutions for practical implementation during first thinning. Preliminary results will be presented at the conference.

## 6.7 Visibility of tree damages from the strip road

Heikki Ovaskainen<sup>\*1</sup>, Niklas Peltoniemi<sup>2,3</sup>, Teijo Palander<sup>2</sup>, Kalle Kärhää<sup>3</sup>,  
Jyry Eronen<sup>2,4</sup>

<sup>1</sup>Metsäteho Ltd, <sup>2</sup>University of Eastern Finland, <sup>3</sup>Stora Enso Wood Supply Finland, <sup>4</sup>Karelia University of Applied Sciences

\*Corresponding author: [heikki.ovaskainen@metsateho.fi](mailto:heikki.ovaskainen@metsateho.fi)

### Keyword:

### Background

In the future, the monitoring of tree damages due to thinning operations can be done automatically during logging, for example, through images taken by cameras attached to forest machines. When taking images from forest machines, the photographing direction is usually away from the strip road, thus damages on the sides and back of the trees are not necessarily visible in the images. The aim of this study was to determine the relationship between the percentage of damage calculated on the basis of visible tree damages from the strip road and the total percentage of tree damage calculated on the basis of all tree damages, and also to examine other factors explaining the total tree damage percentage.

### Material and Methods

The research material consisted of 60 harvesting test plots, which were inventoried from Scots pine (*Pinus sylvestris* L.) dominated thinnings in Eastern Finland in 2017. For each damaged tree the following variables were measured (Figure 1): tree species, diameter (dbh), height of the beginning and end of the damage, height and width of the damage, perpendicular distance of damage from the center line of the strip road, damage angle, visibility of damage perpendicular to the center line of the strip road (1 = visible, 2 = not visible), damage severity (1 = bark removed, 2 = damage to wood material) and estimation of how the damage was caused.

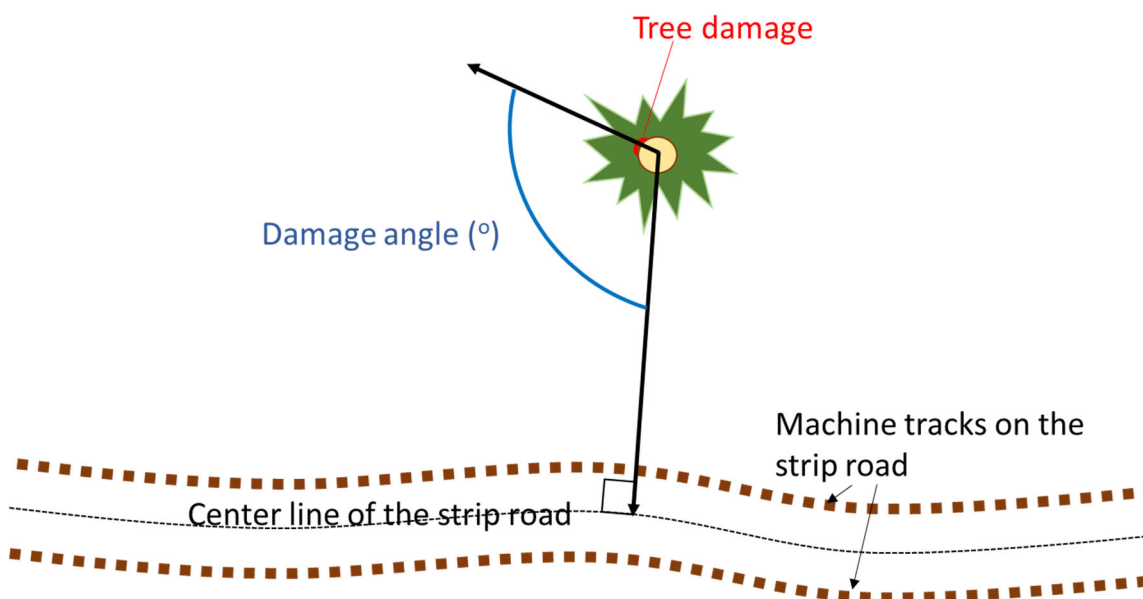

Figure 1. The visibility of tree damages was viewed at an angle of 90 degrees. The angle of the damage relative to the direction of the strip road was measured.

## Results and discussion

In total, 558 tree damages were measured, of which 211 were visible to the strip road. A total of 461 damaged trees were inventoried, of which 183 were damaged so that a damage could be detected from the strip road direction. The average tree damage percentage was 7.2%. When the tree damage is less than 5%, it is in accordance with best practices for sustainable forest management in Finland (Äijälä et al. 2014). Tree damage percentage varied from 0 to 20.0% between the study plots.

The study results indicated that there is a clear dependence between the percentage of damage calculated from the damage to the strip road and the percentage of total tree damage (Figure 2). The best variables to classify damages visible from the strip road and not visible from the strip road were the damage distance from the center line of the strip road, the damage angle from the center line of the strip road, and the height of the damage in the tree.

This research produced new information of tree damages caused by modern harvester work and, at the same time, created principles to build an automatic monitoring system for tree damages.

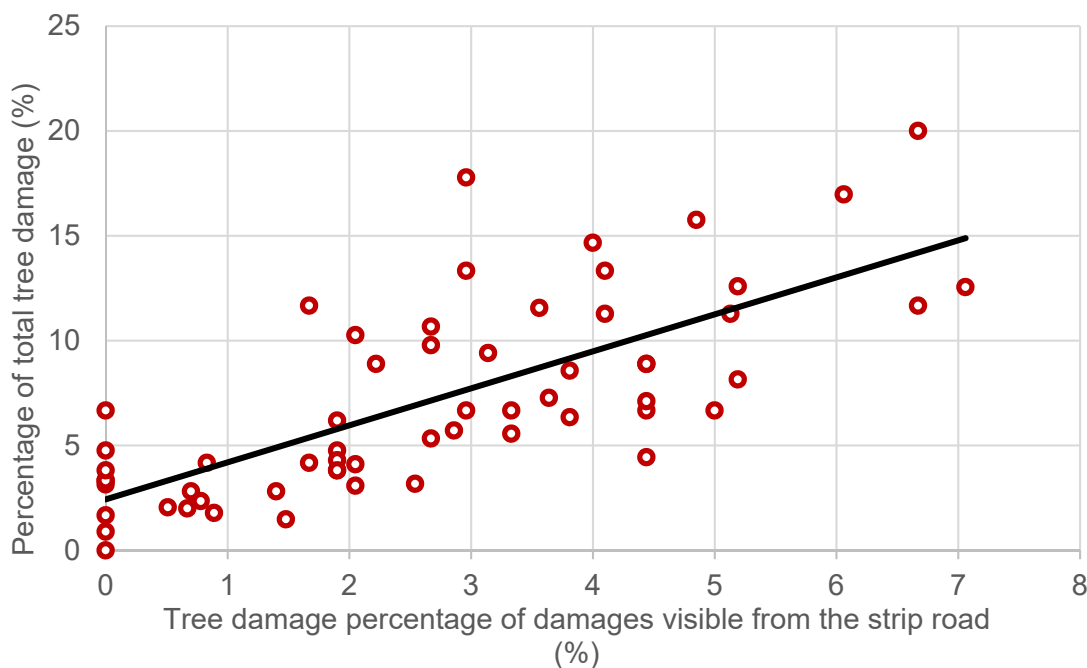

Figure 2. Correlation between tree damage percentage calculated on the basis of damages visible from the strip road and percentage of total tree damage.

## References

- Peltoniemi, N. (2019) Leimikon puustovaurioasteen määrittäminen ajouralle näkyvien runkovaurioiden perusteella. [Determining damage to forest stand marked for harvesting by observing stem damages from strip road]. Master's Thesis. University of Eastern Finland. 64 p.
- Äijälä, O., Koistinen, A., Sved, J., Vanhatalo, K. & Väisänen, P. (ed.) (2014) Metsänhoidon suositukset. Metsätalouden kehittämiskeskus Tapion julkaisuja. 179.



## 7 Forest Contracting and Supply Chain Management





## 7.1 A cost- and productivity calculator for forest harvesting operations in Norway

*Endre Hansen<sup>1\*</sup>, Mikael Fønhus<sup>1</sup>, Bruce Talbot<sup>2</sup>*

<sup>1</sup>Norwegian Forestry Extension Institute, <sup>2</sup>Norwegian Institute of Bioeconomy Research

*\*Corresponding author: eh@skogkurs.no*

**Keyword:** costing, productivity, harvesting, logging

### Abstract

Forest harvesting consists of a number of operations – all with their own cost in terms of time-use. To aid in planning, pricing, and management of forest harvesting operations a cost- and productivity calculator was developed in Microsoft Excel. Based on the site- and forest conditions, and the practical harvesting plan, a time- and cost estimate is produced. The calculator also estimates a completion date based on a start-up date, and the length and number of shifts. It can furthermore be used to simulate time- and cost saving by preparatory measures such as: removal of small trees prior to harvesting, road construction, reduced number of timber product classes. The calculations are based on functions from Sweden and adjusted by Norwegian registrations. The machine costs are based on 2000 operating hours per year. The calculator does not include information on regional differences in forest- and climate conditions, variable moving- and start-up costs, and seasonal differences. Furthermore, a profit margin for the contractor is also not included in the calculations. Thus, the output from the calculator cannot be used directly for pricing of harvesting operations.

## 7.2 Variations in machine utilization and overtime due to the choice of supply chain strategy

Lars Eliasson<sup>1\*</sup>, Anders Eriksson<sup>2</sup>, Sara Holappa Jonsson<sup>1</sup>

<sup>1</sup>Skogforsk, the Forestry Research Institute of Sweden 1, <sup>2</sup>SLU, dept. of Energy and technology

\*Corresponding author: [lars.eliasson@skogforsk.se](mailto:lars.eliasson@skogforsk.se)

### Keyword:

### Abstract

That information-based supply chain management can improve system efficiency and delivery precision for forest fuels are well proven, but how do different management strategies affect variability in work time? Two scenarios were studied; SC1 -reference scenario where residue piles were selected by age, and landings close to another were chipped at the same time; SC2 – Quality driven deliveries prioritising dry residues close to the customer during December to March. Energy deliveries during August to June were simulated for 50 years in each scenario. Chipper-trucks could leave the garage/customer to retrieve another load when this was not expected to cause more than 1.5 h overtime. SC2 reduced the need for additional chipping capacity during the winter. Ordinary chipper-trucks had an average annual overtime of 0.6 h per shift in SC1 which was reduced to 0.3 h in SC2. More importantly, the variation in overtime between months was much smaller in SC2 than SC1, and there was less underutilisation of the chipper-trucks in May and September. Clearly allowing 1.5 hours of expected overtime is too much as this led to shifts with more than 2 hours overtime, which is the legal limit time for truckdrivers. The limit for expected overtime should be reduced to 45 minutes to eliminate most of these occurrences. The lack of supply change management in SC1, increased the need for extra chipper-truck capacity but also to unwanted fluctuations in work loads for chipper-truck operators and, thus, a profitability variation over the year for the owner of said chipper-truck.

## 7.3 Contractor forestry in Northern Sweden: an overview of firm characteristics and economic performance

Thomas Kronholm\*<sup>1</sup>

<sup>1</sup>Swedish University of Agricultural Sciences

\*Corresponding author: [thomas.kronholm@slu.se](mailto:thomas.kronholm@slu.se)

**Keywords:** business model, profitability, entrepreneurs

### Background

Forestry service contractors are the backbone of the Swedish forest industry's supply chain. During the last 20 years, contractors' share of the total work hours spent on forest operations in Swedish forest has doubled (Swedish Forest Agency, 2018). This because a large share of forest work has been outsourced by industrial firms, and private forest owners, to the approx. 3,700 forestry service providers operating in the country today (Häggström et al., 2013; Eriksson, 2016). However, contractors, not only in Sweden, have struggled with low profitability, some even to reach break-even, and the forestry service sector overall has high barriers to business growth and innovation. To enhance the business competitiveness of forestry service firms, the FOBIA (Forest Business Innovation and Advancement) project ([www.luke.fi/fobia](http://www.luke.fi/fobia)) aims to provide knowledge and tools that can help contractors to develop their business, increase their operational efficiency and strengthen their business skills. For this purpose, the business models currently applied by forestry service contractors in Northern Sweden were investigated, as well as the contractors' economic performance.

### Material and Methods

The study focused on Swedish forestry service contractors located in the counties of Norrbotten, Västerbotten, Västernorrland and Jämtland, which corresponds to the geographical area in Sweden that is part of the Northern Periphery and Arctic Programme area (NPA, 2016).

Information about forestry service contractors' business characteristics was collected in the beginning of 2018 from the member and certification registers of the Swedish Association of Forestry Contractors. In total, the registers contained information about 1 603 cases, of which 637 (39.7 %) were located in the study area. The registers contained, for example, information about the contractors' number of employees, number of machines, main type of business (logging or silviculture), services performed and the firm's main customer. However, the type and amount of information available varied between cases. Further, limited liability companies' financial statements, for the period 2012-2016, were collected from the Retriever Business database.

The characterization of forestry service contractors' businesses was based on the framework developed by Benjaminsson (2018). For the analysis of contractors' economic situation, performance indicators such as net profit margin, equity ratio and liquidity ratio were calculated.

### Results and discussion

Results show that the majority of contractors in Northern Sweden offer harvesting (59.9 %) and forwarding services (65.2 %). These services are often combined, as 48.3 % of all contractors offered both services. Furthermore, 82.9 % of those offering harvesting services also offered forwarding. Cleaning was offered by 83.7 % of those classified as silvicultural contractors, equivalent to 23.3 % of all contractors. A large share of the silvicultural contractors also offered planting services (41.3 %), but planting was rarely the only service offered. Other services offered by this group was soil scarification (12 %), planning (10.3 %) and ditching (6.5 %). The distribution between contractors focusing on either silvicultural or logging operations were in line with previous studies (Häggström et al. 2013).

Contractors with machines usually had one or two, with an average of 2.14 machines per contractor in the study area. Harvesting contractors' mean book value of machines and inventories in 2016 was approx. 409 000 euro, while it for silvicultural contractors was 67 000 euro. During the period 2012-2016, a minor decrease was identified in the book value of machines and inventory. This may suggest that the investments made by contractors in new machines have been low during the period. Based on the contractors' financial statements, the average number of employees in 2016 was 5.0 for logging contractors and 5.9 for silvicultural contractors. Further, the results showed that the forestry service market in the north is dominated by a few large service buyers. Of the contractors who had a main customer, three out of four were primarily working for SCA (27.4 %), Norra Skogsägarna (11.2 %), Norrskog (11.2 %), Holmen (12.4 %) or Sveaskog (13.5 %). On local level, the availability of customers may be even more restricted as, for example, the forest owners' associations are not operating in the whole study area.

In 2016, the average turnover for harvesting companies in the study area was € 694 000 (median € 545 000) and for silvicultural contractors € 478 000 (median € 316 000). In the same year, the median net profit margin was 2.1 % for logging contractors and 3.2 % for silvicultural contractors. However, 26.9 % of the contractors did not make a profit (i.e. their result was  $\leq 0$ ). On an aggregate level, contractors' equity and liquidity ratios were on tolerable levels. However, logging firms with a turnover above € 800 000 were found to have a liquidity below 100 % during the whole period investigated, meaning that their short-term liabilities constantly exceeded their current assets.

A conclusion of this study is that many contractors, due low profit margins and for some poor liquidity, are vulnerable to unforeseen events that disturb their normal operations. For example, this could be seen during the summer of 2018 when extreme weather lead to increased costs for fire-prevention and loss of income due to standstills. In the long-run, increased margins are desirable in order to secure the existence of entrepreneurs willing to invest in the development of the forestry service sector.

## Acknowledgments

This study is a product of the FOBIA project, funded by the European Union's Northern Periphery and Arctic Programme 2014-2020.

## References

- Benjaminsson, F. (2018) Development of a tool to characterize business models for forestry services, Swedish University of Agricultural Sciences, Umeå, Sweden.
- Eriksson, M. (2016) Developing client-supplier alignment in Swedish wood supply. Swedish University of Agricultural Sciences, Umeå, Sweden.
- Hägström, C., Kawasaki, A., Lidestav, G. (2013) Profiles of forestry contractors and development of the forestry-contracting sector in Sweden, *Scandinavian Journal of Forest Research* 28:4, 395-404.
- [NPA] Northern Periphery and Arctic Programme Secretariat. (2016) Northern Periphery and Arctic Cooperation Programme 2014-2020. [http://www.interreg-npa.eu/fileadmin/Programme\\_Documents/Approved\\_Cooperation\\_Programme\\_Jan2016.pdf](http://www.interreg-npa.eu/fileadmin/Programme_Documents/Approved_Cooperation_Programme_Jan2016.pdf)
- Swedish Forest Agency. (2018) Forestry labour force in 2017. Swedish Official Statistics, Swedish Forest Agency.

## 7.4 Identification of success factors of a wood harvesting enterprise

Pasi Rikkonen<sup>1</sup>, Katri Hamunen<sup>1</sup>, Paula Jylhä<sup>1,\*</sup>

<sup>1</sup>Natural Resources Institute Finland

\*Corresponding author: paula.jylha@luke.fi

**Keywords:** contracting, economics, profitability, management

### Background

The Finnish wood harvesting business has undergone a significant structural change during the past two decades. The size of harvesting enterprises has grown. Besides harvesting, they are also responsible for various additional tasks (Nieminen, 2015). Between 2012–2017, the Finnish forest industry invested 4 419 million euros in the production of wood products, pulp and paper (Natural Resources Institute Finland, 2019). At the same time, the removal of domestic roundwood reached a record level of ca. 63 million m<sup>3</sup>, while the trend in wood procurement costs was declining (Natural Resources Institute Finland, 2019). In 2017, the operating profit of a median wood harvesting company was only 1.26% (Jaakkola, 2018). 10% is considered a good level in the branch (Mäkinen, 2018).

Sustainable wood harvesting business is a prerequisite for a secure raw material supply of the forest industry. Problems with profitability make the recruitment and retention of skilled employees challenging (Jaakkola, 2018). The majority of the roundwood consumed by the Nordic forest industry originates from the areas with low economic diversity. Therefore the success of wood harvesting enterprises is crucial also to rural communities. We analysed the economic status and business models of Finnish wood harvesting companies. At the next stage, the interlinkages between the business model and the economic success will be analysed, with the focus on developing methodology for upgrading the business models. *The study was conducted in the FOBLA project, aimed at improving the business management skills of forestry service entrepreneurs. The project is funded by the Northern Periphery and Arctic 2014–2020 Programme.*

### Material and Methods

The overall profitability of 84 wood harvesting companies located in Northern and Eastern Finland (Table 1) was analysed based on public financial accounts (Asiakastieto, 2019). The economic indicators used in the analysis were turnover, return on investment (ROI), debt ratio and quick ratio. A sample of 19 entrepreneurs was selected for in-depth interviews. These interviews were analysed based on the Business Model Canvas (BMC) developed by Osterwalder et al. (2005). The BMC was adapted to the wood harvesting business as suggested by Benjaminsson (2018), and the business models were analysed according to the following main components: 1) customers and contracts, 2) organization of activities, 3) resources, 4) economy and earning logics, and 5) business development (including co-operation and networks).

Table 1. Classification of the enterprises (limited companies) included in the data

Economic analysis (n = 84)		Interviews (n = 19)	
Category	Turnover	Category	Turnover
G1	> 2 million euros (n=18)	L	> 2 million euros (n=4)
G2	1–2 million euros (n=20)	M	500 000–2 million euros (n=7)
G3	500 000–1 million euros (n=25)	S	small, < 500 000 euros (n=8)
G4	< 500 000 euros (n=21)		

### Results and discussion

Between 2012 and 2016, only the turnover of the biggest companies had increased (Fig. 1). Based on the average ROI of ca. 7%, the overall profitability of wood harvesting was satisfactory. The smallest companies struggled with profitability, which is seen in all indicators included in the analysis. The overall debt ratio of

the industry indicates that some companies are debt-ridden, but the median debt ratio is reasonable. The quick ratio shows that the liquidity is fairly good in general.

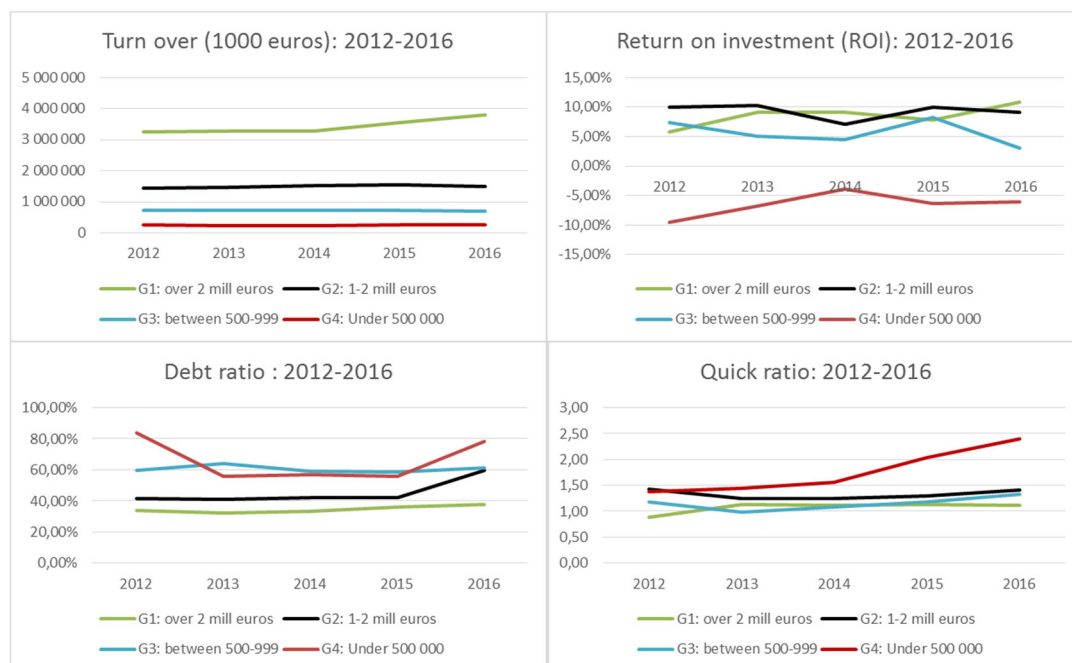

Figure 1. The financial ratios for 84 companies within the NPA study area.

The smallest companies were typically subcontractors of the prime contractors, while the bigger players had direct contracts with the forest industry integrators, independent sawmills, forest management associations (FMAs) and Metsähallitus (state-owned forest enterprises). The biggest companies had also developed various networks in order to strengthen their competitiveness. Besides the decline in the harvesting fares and increase in costs (Jaakkola 2018), unsatisfactory profitability may also reflect the competition between the harvesting enterprises and the power in negotiations between actors in the market (Porter, 1980). The decline (ca. 8%) in the average harvesting cost (incl. overheads) of industrial roundwood (Natural Resources Institute Finland, 2019) supports the theory of Porter (1980). As wood harvesting business is increasingly based on networking, good business management skills are required for long-term success. The BMC holds promising prospects for developing a practical methodology for pinpointing business model components that require enhancement.

## References

- Asiakastieto (2019) The Voitto financial statements database, available at: <https://www.asiakastieto.fi/web/en/>.
- Benjaminsson F. (2018) Development of a tool to characterize business models for forestry services, a M.Sc. thesis, Swedish University of Agricultural Sciences, Umeå, 41 p.
- Osterwalder, O., Pigneur, Y. & Tucci, C. (2005) Clarifying business models: origins, present, and future of the concept, *Commun Assoc Inf Syst.*, 15:1-40.
- Jaakkola, S. (2018) Koneurakoinnin kannattavuus ja rekrytointivaikeudet käsi kädessä, *Koneyrittäjä* 7: 40, p. 42.
- Mäkinen, P. 2018. Elinvoimainen yrittäjyys 2025, presentation, Metsäpäivät 23.11.2018. 18 p., available at: <https://www.koneyrittajat.fi/media/Julkinen/Liitteet/Tapahtumat/Metsapaiva2018/o3Makinen.pdf>.
- Natural Resources Institute Finland (2019) Statistics database, available at: <http://statdb.luke.fi/PXWeb/pxweb/en/LUKE/?rxid=dc711a9e-de6d-454b-82c2-74ff79a3a5e0>.
- Nieminen, A. (2015) Resurssitehokas puunkorjuu, *Tapion raportteja nro 5*, 34 p.
- Porter, M. E. (1980) *Competitive Strategy: Techniques for Analyzing Industries and Competitors*, Free Press, New York. 436 p.

## 7.5 A new integrated model for production and flow management

Sara Holappa Jonsson<sup>1\*</sup>, Victor Asmoarp<sup>1</sup>

<sup>1</sup> Skogforsk, The Forestry Research Institute of Sweden, 751 83 Uppsala Sweden

*\*Corresponding author: sara.holappajonsson@skogforsk.se*

### **Keyword:**

### **Abstract**

A new integrated model for production and flow management increases the possibility of using the forest biomass as resource efficiently as possible. The model maximizes the profit in consideration to wood value and transportation costs when bucking all stems in a stand to products for a given industry. This should enable a smarter wood supply with a larger proportion of biomass transported to the closest destination from the harvesting site, given that the quality aspects and demand for the specific receiving industry are met. The aim of the project was to show how an integrated model could influence both the bucking decision and the destination decision, which should enable that a larger proportion of the biomass from each individual stand could be transported to the nearest industry with lower environmental impact and increased profitability within the entire wood supply chain. Case studies at two forest companies have been performed, in which the model was granted to produce the original set of products to the original destined industries from each individual stand. For each case two scenarios were studied, A) with transportation costs and B) without transportation cost. The result showed that large differences in prices for different products results in small changes. However, small differences in prices will result in larger changes and increased net value within the supply chain. In both cases, the total net value increased when the model considered transportation cost.



## 7.6 Improving resource efficiency in the forest sector through digital declarations of raw material properties

*Maria Nordström<sup>1\*</sup>, Johan J Möller<sup>1</sup>, Sara Holappa Jonsson<sup>1</sup>, Lars Wilhelmsson<sup>1</sup>, Thomas Grahn<sup>2</sup>, Anders Lycken<sup>2</sup>, Lars Wallbäcks<sup>2</sup>, Dan Olofsson<sup>2</sup>.*

<sup>1</sup>Skogforsk, the Forest Research Institute of Sweden; <sup>2</sup>RISE, Research Institutes of Sweden

*\*Corresponding author: maria.nordstrom@skogforsk.se*

### **Keyword:**

### **Abstract**

Competitiveness of the forest sector is key for building a strong bioeconomy. It has long been known that raw material properties impact process efficiency and properties of the final products of forest industry. Prior research has also shown that wood properties vary within individual trees as well as between trees in a harvesting object and between different geographic regions. So far this variation has mostly been regarded as a problem for the industry having to cope with varying raw material for their processes. However, wood properties can be described using models based on factors like geographic position of the tree, species and tree dimensions. Since the data infrastructure to make available data on these factors has not been in place for very long, there is still a lack of tools to match wood properties of the forests available for harvest with the demands of the industry. The ongoing digitalization of the forest sector now offers great potential to close the digital information chains and thus supply information of the raw material for planning of harvesting operations and process control. In this project, we aim to develop digital infrastructure for the forest sector to calculate and communicate raw material properties and develop and evaluate methods from these data to increase competitiveness for the industry. Data from harvesters and forest inventories are used as input to property modelling and validated using data from x-ray measurements at sawmills. The results are promising.

## 8 Posters



## 8.1 AVATAR – Advanced Virtual Aptitude and Training Application in Real Time

*Jaeger, D<sup>1\*</sup>, Björheden, R<sup>2.</sup>, Talbot, B<sup>3.</sup>*

<sup>1\*</sup>Department of Forest Work Science and Engineering, Georg-August-Universität Göttingen,

<sup>2</sup>Forestry Research Institute of Sweden, Skogforsk, <sup>3</sup> Norwegian Institute for Bioeconomy Research, NIBIO

*\*Corresponding author: dirk.jaeger@uni-goettingen.de*

### Background

The demand for highly skilled operators in remote rural settings constitutes a challenge for modern timber production. This is partly due to the high capital loading of cut-to-length (CTL) systems, which requires a correspondingly high throughput of timber to make the investment feasible. High productivity requires high skill levels, which need to be fostered through suited training programmes. Diagnostic feedback systems indicating detrimental work patterns and offering corrective strategies on the fly could be very helpful. Constant mentoring throughout the career path of a professional machine operator is the most appropriate way to ensure efficient operation, reduction of machine downtime and sick leave days, in order to utilize the full technical potential of CTL equipment.

CTL-harvesters have more than 10 electro-hydraulic operations on each joystick, requiring around 3500 activations per hour in maintaining an acceptable production rate. The operator must select, fell, process into logs of differing value, quality and dimension, about two trees per minute, over an 8-10 hour working day, causing high mental workload, fatigue and further performance reduction among normal to lesser skilled operators. It takes up to 3 years for a new operator to perform at the full extent of their aptitude. Yet, even experienced operators exhibit productivity differences of up to 40% under similar working conditions. Skilled forest machine operators are easily lost to construction and other sectors with higher salaries and more centralised work opportunities. Given that profit margins for forest contractors are typically only 4-6% of turnover, there are strong and obvious incentives in retaining skilled operators while rapidly improving the learning rate and level of production from new operators. Despite good intentions for further mechanization and eventual automation, the unique forest working environment retards progress, which keeps the operator in the current man-machine system as both the focal point and the bottleneck in achieving higher operational efficiency. Therefore, consistent learning and training of operators, with a focus on personal skills and work patterns, and in combination with technical assistance and feedback-systems, remain the prime methods in improving operational efficiency and value generation.

### Objective

The objective of the AVATAR proposal is to demonstrate how real time automated feed-back systems can increase operational efficiency and perceived job satisfaction in mechanised timber harvesting – while reducing mental workload. Through this, the project will contribute to efficiency improvements of CTL operations for enhanced timber utilization at higher value-added resource recovery, alongside occupational health and safety, and thus will support the implementation of a sustainable and competitive bio-economy in Europe.

### Goals

- Reduce training and skills demands on new operators while reducing workload on skilled operators
- Broaden the operator base by contributing to a more accessible, balanced and attractive work environment for both genders

- Clarify which data are most closely associated with individual performance and how these can be gainfully used within the GDPR framework
- Unlock the full potential of current production systems and thereby substantially reduce cost of biomass supply
- Increase detail data capture on European forests through promotion of CTL systems running StanForD
- Promote R&D cooperation within and between Scandinavia and central-Europe

## Methods

Know-how from work method instructors will be used to define quantitative measures of work performance. These measures will be further elaborated in order to investigate options to include machine on-board systems, but also sensor and scanner-based technology of data generation and sharing, to be utilized for performance evaluation, and how it can be incorporated in an individual feedback approach for coaching. Alongside the technical realization, the evolution of a full concept to make use of the personal data of the individuals under strict compliance with the EU GDPR (General Data Protection Regulation) for a tailored feedback and coaching approach is an essential part of the whole AVATAR process.

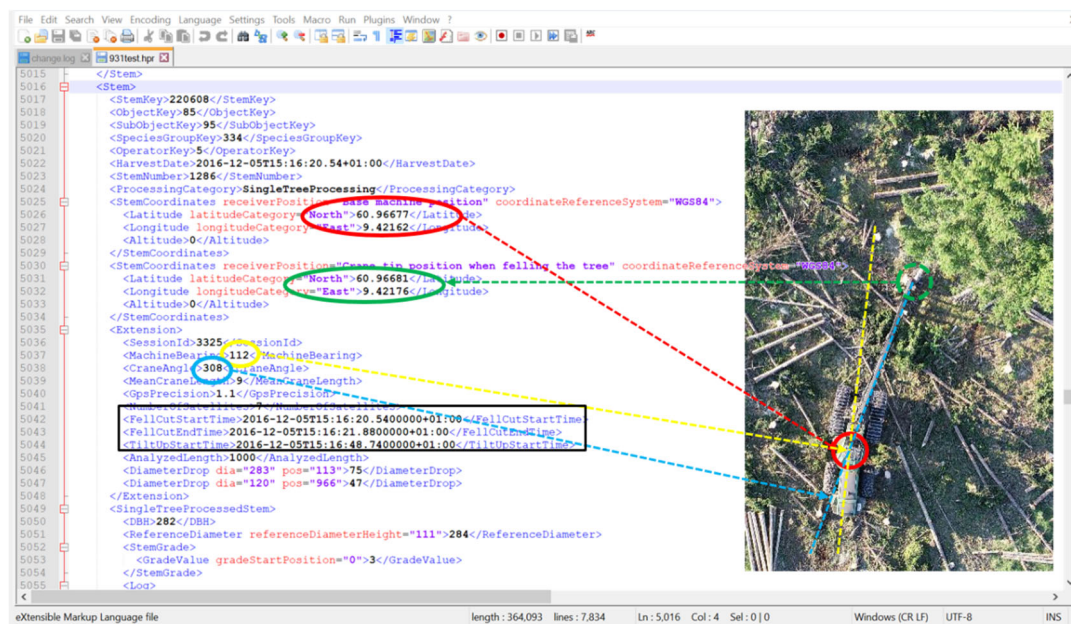

Figure 1. In addition to qualitative data, working methods will be analysed using a combination of StanForD, CAN bus, and operating environment data

## Project information

The Georg-August University of Göttingen is overall project coordinator, with participation from Landesbetrieb Wald und Holz, NRW and Leibniz Research Centre for Working Environment and Human Factors in Germany, in Sweden, the Swedish Forestry Research Institute (Skogforsk), and in Norway, the Norwegian Institute for Bioeconomy Research (NIBIO), the Forestry Extension Institute (Skogkurs) and Optea AS make up the consortium. The project runs from February 2019 to January 2021. The AVATAR project is funded through the ERA-NET Cofund Action 'ForestValue', which includes joint national funding from the 3 participating countries (Germany, Sweden, Norway). See the project website at <http://www.avatar.uni-goettingen.de/>



**NIBIO**

NORWEGIAN INSTITUTE OF  
BIOECONOMY RESEARCH



**SNS**

Nordic Forest Research

The basis of bioeconomy is the utilization and management of marine and terrestrial biological resources. The institute is to contribute to food security and safety, sustainable resource management, innovation, and value creation through research and knowledge production within food, forestry, and other bio-based industries. NIBIO delivers research, managerial support, and knowledge for use in national preparedness, as well as for businesses and the society at large. NIBIO is to become the leading national center for the development of knowledge within the field of bioeconomy.

NIBIO is owned by the Ministry of Agriculture and Food as an administrative agency with special authorization and its own supervisory board. The main office is located at Ås, just outside Oslo. The institute has several regional units and a departmental office in Oslo.

The Norwegian Institute of Bioeconomy Research (NIBIO) was founded on July 1st 2015 as a fusion of the Norwegian Institute for Agricultural and Environmental Research (Bioforsk), Norsk institutt for landbruksøkonomisk forskning (NILF), and the Norwegian Forest and Landscape Institute.

NIBIO Department of Forest management and technology, Norway

[www.nibio.no](http://www.nibio.no)

Twitter: @NIBIO-no / Facebook: @Nibio.no

